



SAPORE ITALIANO - *italian flavor*

MO-
DERN

INDICE - Contents

3
L'AZIENDA
Our Company

4
LA NOSTRA FILOSOFIA
Our philosophy

5
100% MADE IN ITALY
100% Made in Italy

6
L'ARTIGIANALITÀ
CRAFTSMANSHIP

7
LA SOSTENIBILITÀ
Sustainability

8
LAMELLARE MASSICCIO
Blockboard

9
IL NATURAL WOOD
Natural wood

10
MDF LACCATO
Lacquered MDF

11
LEGNO MASSICCIO
GIUNTATO A PETTINE
Solid wood with finger joints

12
ELEMENTI IN MASSICCIO
Solid wood parts

13
L'INCIZIONE AL LASER E
IL PRESSATO
Laser engraved and pressed panels

14
IL VETRO E L'ALLUMINIO
Glass and aluminium

15
IL MARMO
Marble

16
IL GRESS PORCELLANATO
Porcelain stoneware



L'AZIENDA
our company



Old Line è un'azienda che affonda le sue radici nella tradizione ebanistica veneta. Nata 40 anni fa da artigiani accomunati dall'amore per la lavorazione del legno, oggi è un'industria strutturata e punto di riferimento nel mondo della cucina tradizionale. Con alle spalle un importante bagaglio di esperienza nel settore, oggi la seconda generazione continua ad immettere sul mercato prodotti dal design classico, contestualizzati in una modernità compositiva per l'arredo di spazi esclusivi. L'utilizzo di materiali pregiati, la cura dei dettagli e di soluzioni tecniche innovative, sono la chiave per la realizzazione di cucine accoglienti, ospitali, funzionali e di raffinata eleganza.

Old Line's roots are deeply embedded in the cabinet-making tradition of the Veneto region in Italy. Established 40 years ago by artisans who shared a love for timber, ours is now a well-organised company that others in the world of traditional kitchens look up to. Thanks to a heritage of great experience in the sector, the second generation at the helm of the company is still making classic furniture for the market, now contextualised in modern layouts to furnish exclusive spaces. Prized materials, care to detail and innovative technical solutions are the keys to building inviting, cosy, functional and exquisitely elegant kitchens.



LA NOSTRA FILOSOFIA *our philosophy*

Recupero e valorizzazione della tradizione.

Questi sono i cardini attorno ai quali ruota la nostra filosofia aziendale. Old Line, infatti, proprio perché nata come piccola realtà artigianale, non ha mai scordato le proprie origini. A quest'ultima continua infatti ad attingere, in un continuo processo innovativo dove la tradizione si sposa con le più moderne tecniche produttive.

Attraverso la valorizzazione del know-how tramandato di padre in figlio, l'azienda è oggi espressione di un'imprenditorialità sostenuta da una genuina passione per il legno e per il design.

To bring back and enhance tradition.

This is the cornerstone of our company philosophy.

In fact, since we started as a small, woodworking business, we have never forgotten our origins and we keep drawing from them, in an ongoing process of innovation in which tradition is paired with the most modern production technologies. By making the most of the know-how handed down from father to son, today our company's business skills are backed up by an authentic passion for wood and design.

100% MADE IN ITALY *100% made in italy*

Per Old Line il Made in Italy è un'imprescindibile caratteristica dei propri prodotti. Ogni componente viene infatti lavorato all'interno dell'azienda, dal più semplice al più complesso.

Solo così è possibile garantire l'intera filiera produttiva, con un costante e capillare controllo della qualità dei materiali e delle finiture, per ottenere mobili di eccellenza caratterizzati da un inconfondibile stile italiano.

The furniture produced by us at Old Line is entirely Made in Italy: an intrinsic and indispensable feature of all our products. Each part, no matter how simple or complex, is made on our premises. We know no other way to guarantee the entire production chain, by means of thorough, ongoing quality controls carried out on materials and finishes to obtain top-quality furniture marked by the unmistakable Italian style.



L'ARTIGIANALITÀ *craftsmanship*

Artigianalità, ovvero saper costruire con amore, come un tempo. Per Old Line questo aspetto fa parte del dna aziendale perché le nostre origini sono proprio quelle di artigiani del legno.

Scegliamo con cura i materiali, selezionandoli e testandoli, consapevoli che la bontà della materia prima è fondamentale per l'ottenimento di prodotti di alta qualità. Nelle lavorazioni impieghiamo tutta la nostra competenza, curando ogni dettaglio, forti di una consolidata esperienza ebanistica.

Craftsmanship means knowing how to make things with love and care, just like they used to be in the past. Since we started out as cabinet makers, this is still an intrinsic part of our makeup. We choose our materials carefully, selecting them and testing them, well aware that excellent raw materials are essential to make a top-quality product. We invest all our skills in crafting our furniture, taking care of every detail, backed up by our sound experience as cabinet makers.



LA SOSTENIBILITÀ *sustainability*

La salvaguardia dell'ambiente è da sempre un aspetto basilare per Old Line.

I nostri processi produttivi vengono continuamente ottimizzati, controllati ed aggiornati.

L'utilizzo di energia elettrica autoprodotta copre fino al 50% del fabbisogno energetico, prezioso contributo ad un processo virtuoso di effettiva eco-sostenibilità.

For us at Old Line, environmental awareness is essential. Our production processes are continuously optimised, checked and updated. Up to 50% of our electricity requirements are self-produced: an important contribution to a virtuous process of authentic eco-sustainability.



LAMELLARE MASSICCIO *blockboard*



Lamellare massiccio, ovvero un pannello costituito da 3 strati di legno. Le due facce esterne sono composte da lamelle parallele incollate in senso longitudinale, mentre lo strato centrale è incrociato e interamente chiuso. Il risultato di questo assemblaggio è quello di un pannello massiccio e molto stabile, in cui le tensioni naturali dei legni si bilanciano a vicenda, evitando possibili deformazioni sia della superficie che dell'anima del pannello stesso, scongiurando curvature dovute a cambi repentini di calore ed umidità. Legno massiccio, quindi, a tutti gli effetti, ma con i vantaggi strutturali di un lamellare di altissima qualità.

Blockboard is a panel consisting of 3 layers of wood. The two external faces are composed of parallel layers of plywood glued together lengthwise while the core is made up of cross-grained wood plies completely covered by the outer layers. This results in a very strong, solid panel in which the natural tensions of the wood layers are balanced out to prevent deformations of the surface and core and to avoid warping due to sudden changes in temperature and humidity. Solid wood, to all effects and purposes, with the structural advantages of extremely high-quality blockboard.

IL NATURAL WOOD *natural wood*



Le finiture Natural Wood rendono ancora più prezioso il multistrato marino di classe 3, caratterizzato da ottime prestazioni in termini di durabilità. A testimonianza della particolare attitudine a resistere al contatto con l'acqua viene impiegato principalmente in campo nautico. Il multistrato marino si differenzia dal multistrato classico per il particolare tipo di resina utilizzata per incollare tra di loro i vari strati di legno, denominata resina fenolica. La superficie delle nuove finiture Natural Wood subisce una particolare pressatura effettuata con delle matrici in acciaio che conferiscono al legno un aspetto ancora più naturale e particolare sia visivamente che al tatto. Le finiture Natural Wood sono caratterizzate dall'utilizzo di rivestimenti composti da fogli di legno naturale dello spessore di circa 2 mm in grado di offrire una maggiore resistenza all'usura. Le superfici vengono trattate, nelle varie finiture, utilizzando esclusivamente vernici ad acqua di alta qualità e resistenti all'umidità, contribuendo, inoltre ad elevare il livello di protezione della salute dell'uomo e dell'ambiente. Il natural wood viene impiegato per la realizzazione di consolle tops e mobili.

Our Natural Wood finishes make our grade 3 marine plywood - which features excellent durability – even more precious. The fact that it is particularly suitable for use in contact with water is proven by its principle utilization, i.e. boat building. Marine plywood differs from traditional plywood because of the special phenolic resin used to stick the various wood plies together. The new Natural Wood surface finishes are achieved by means of a special steel die pressing process that gives the wood an even more natural and precious appearance and feel. The Natural Wood finishes consist in approximately 2-mm thick sheets of natural wood which are used to face the panels and make them more resistant to wear. The surfaces are treated exclusively with top-quality, water-based varnishes in different finishes that are resistant to humidity and contribute to protecting the environment and the health of the user. Natural wood is used to make breakfast bars, worktops and furniture.

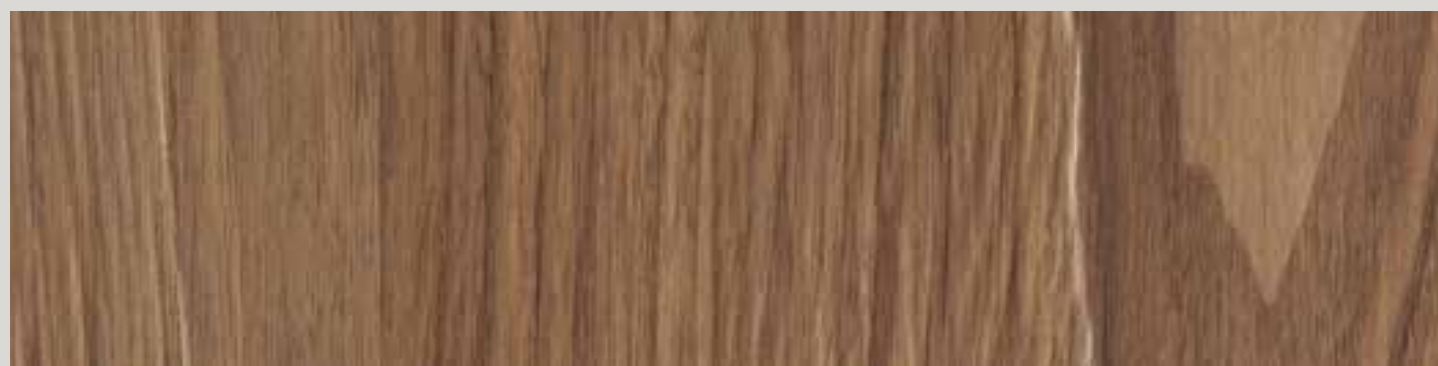

Noce Canaletto
Black walnut

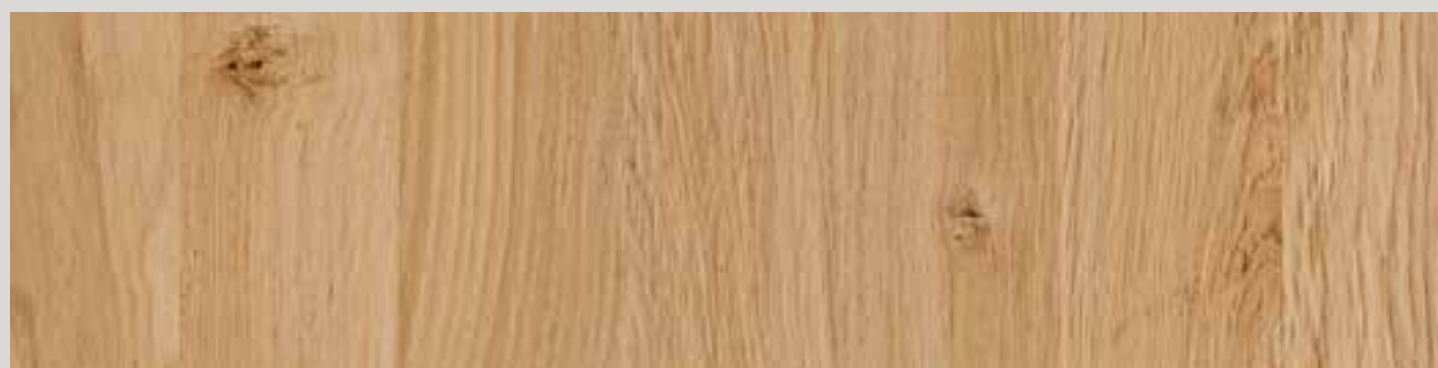

Rovere Nodato
Knotted oak

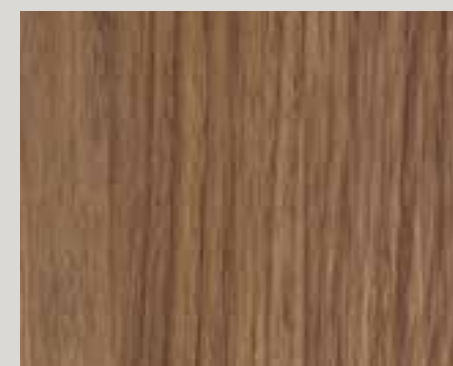

Multistrato Noce Canaletto
Black Walnut plywood



Multistrato Rovere Vintage / Nero
Vintage / Black Oak plywood



Multistrato Rovere Nodato
Knotted Oak plywood



Multistrato Rovere termocotto
Heat-treated Oak plywood



Multistrato Olmo
Elm plywood



MDF LACCATO

lacquered MDF

MDF, Medium-Density Fibreboard.

Questo tipo di pannello è costituito da un finissimo agglomerato di legno pressato a 'media densità'.

Privo di venatura, si presta particolarmente a lavorazioni di fresatura, sagomatura e soprattutto laccatura.

Quest'ultimo processo produttivo, solitamente effettuato a spruzzo, permette di ottenere superfici verniciate lucide o opache con caratteristiche di finitura eccellenti.

Un'ampia gamma cromatica dei laccati consente di personalizzare la cucina con colorazioni dai toni naturali che donano al mobile un tocco di esclusività e raffinatezza

MDF, Medium-Density Fibreboard.

This is a very fine wood chip composite panel pressed at "medium density". Since it has no grain, it is particularly suitable for milling, shaping and especially lacquering.

The latter process is usually performed by spraying the lacquer which achieves excellent results in terms of matt or gloss surface finishes. A wide range of lacquer colours can customise any kitchen with natural shades that give cabinets a touch of exclusivity and refinement.



LEGNO MASSICCIO GIUNTATO A PETTINE

finger-jointed solid wood

Il legno è una materia "viva", che nel tempo continua a mutare. Per evitare possibili alterazioni, ricorriamo all'uso di legni rigorosamente stagionati che vengono selezionati e giuntati a "pettine" garantendo un'elevata stabilità.

Il risultato finale è quello di componenti che una volta assemblati danno forma e vita a mobili pregiati, nei quali il legno stabilizzato assolve pienamente una funzione strutturale di lunghissima durata.

Wood is "alive" which means that it continues to change with time. To prevent our wood from warping we use only timber that has been properly seasoned, selected and finger-jointed to ensure superior stability. The end result consists of assembled parts that become prized pieces of furniture made of stabilised timber that fully performs its structural task for a very long time.



Finitura Noce Canaletto
Black Walnut finish



Finitura Rovere Nodato
Knotted Oak finish

ELEMENTI IN MASSICCIO

solid wood parts



Per ottenere la massima qualità, utilizziamo legno massiccio anche a livello di componentistica interna.

Questo significa che parti non direttamente visibili come sponde cassetto, fondi ed altri componenti, sono rigorosamente in legno.

Nell'assemblaggio dei cassetti viene utilizzata la tecnica a 'coda di rondine', un incastro ereditato dalle tecniche ebanistiche del passato, ma che ancora oggi costituisce il miglior sistema in assoluto per ottenere giunzioni perfette e durature nel tempo.

To achieve the best quality we even use solid wood for the interior parts of our cabinets. This means that even the parts that aren't immediately visible such as drawers sides, bases and other elements are made exclusively of wood.

The dovetail joint technique, handed down by cabinet makers of old, is used to assemble drawers because it is still the best method to obtain perfect, long-lasting joints.

INCISIONE LASER

laser engraving



La tradizione incontra l'innovazione. La nostra produzione, fondata sui principi dell'artigianalità per la cura del dettaglio e della qualità, si avvale anche di tecniche moderne e sofisticate.

Una di queste è rappresentata dall'intarsio al laser, una lavorazione altamente tecnologica che ci consente di incidere le superfici lignee, dando sfogo alla creatività con disegni 'tono su tono'.

Un tocco di modernità che riesce ad esaltare le caratteristiche del vero legno, mettendone in risalto le venature attraverso una palpabile matericità.

Tradition meets innovation. Our production, based on the principles of craftsmanship, care to detail and quality, also makes use of sophisticated, modern technologies. One of these is laser engraving, a very technological process that allows us to cut into the wooden surfaces and use our creativity to design "tone-on-tone" embellishments. A touch of modernity that sets off the characteristics of authentic wood, highlighting its grain by means of a texture that can be felt.



Schiena in massello dogato
Boarded solid wood back panel



Sponde cassetto con incastro a coda di rondine
Drawer sides with dovetail joints



Ripiani in legno massello
Solid wood shelves

PRESSATO

pressed panels



Un'altra tecnica utilizzata per arricchire le superfici è quella del pressato.

Con particolari macchinari, i pannelli vengono sottoposti ad una pressione che ne sagoma le superfici, dando vita ad effetti tridimensionali di grande impatto visivo.

Le geometrie riprodotte creano motivi a sbalzo che impreziosiscono il mobile, enfatizzando la preziosità delle essenze.

This is another technique used to decorate surfaces. Special equipment is employed to apply pressure to the panels and achieve really impressive 3D patterns on the surfaces.

These geometric designs decorate the furniture while enhancing the beauty of the wood.

IL VETRO *glass*



Il vetro utilizzato è ecocompatibile al 100%. Di tipologia extrachiaro o extrachiaro sabbato, viene retro verniciato in tutti i colori di gamma, consentendo la progettazione di prodotti "tono su tono". Eventuali variazioni cromatiche nella composizione del vetro, sono dovute al fatto che è un materiale costituito da composti naturali non sempre identici. La proposta Old Line si articola in tops semplici - tops rettilinei - e in tops integrati, che includono la parte lavabo rendendo il top molto minimale e facilitandone al contempo pulizia ed igiene. Disponibili in tutte le medesime finiture dei prodotti possono, a richiesta, essere realizzati anche in tutta la scala NCS - scala colori esistenti -.

CERTIFICAZIONE: UNI EN ISO 14688-2:2013.

We use only 100% eco-compatible glass. Extra-clear and satin extra-clear glass is lacquered on the reverse side in all the colours of the range to achieve tone-on-tone products. Any variations in colour of glass finishes are due to the fact that glass is made of natural compounds that are not always identical. Old Line offers plain worktops – straight worktops – and worktops with integrated sinks for a very minimal look that also favours hygiene and makes cleaning a breeze.

Available in all the finishes of our products, they can, on request, be finished in all the NCS colours and in the colours available on catalogue.

CERTIFICATION: UNI EN ISO 14688-2:2013.

IL MARMO *marble*



Marmo naturale. Il marmo è un materiale naturale costituito da carbonato di calcio, presenta differenze di tonalità e, per la sua unicità, non è mai perfettamente riproducibile; piccoli fori, venature più o meno marcate, sono infatti le naturali caratteristiche di questo prodotto. I marmi tendono ad assorbire attraverso le loro microscopiche porosità i liquidi per poi liberarli tramite evaporazione. La natura calcarea del marmo lo rende un materiale esposto al rischio di assorbimento di sostanze che potrebbe macchiarlo immediatamente - profumi, cosmetici, smalti ed altre sostanze -; una buona e costante manutenzione, senza eccedere nell'uso di saponi o detersivi inadatti ne conserva la brillantezza.

Natural marble. Marble is a natural material made of calcium carbonate and is so unique that it can never be perfectly reproduced because its shades and vein change from one slab to another. Small holes and more or less visible veins are natural features of this product. Marble tends to absorb liquids through its microscopic pores that subsequently evaporate. Since marble is made of limestone it may absorb substances such as perfumes, cosmetics, varnishes and the like that stain it irreparably. Its shine is preserved with constant care, making sure unsuitable soaps and detergents are used sparingly.

L'ALLUMINIO *aluminium*

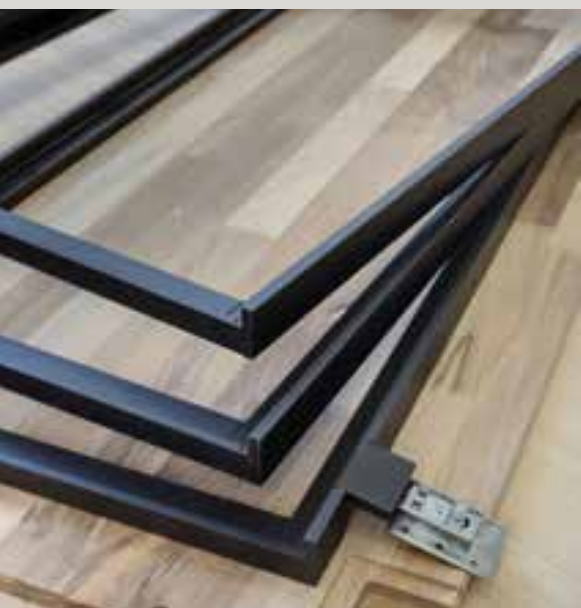

Alluminio è sinonimo di leggerezza, duttilità e stabilità. Utilizziamo questo materiale soprattutto nell'assemblaggio di frontali vetriati. Una cornice in alluminio, infatti, è la soluzione migliore per intelaiare un vetro. Leggero e allo stesso tempo solido, l'alluminio si presta ad ogni tipo di lavorazione e fornisce ineguagliabili garanzie di stabilità. Tradizionalmente legato alla sua colorazione naturale, oggi è disponibile anche in tonalità che sposano perfettamente le finiture del mobile nel quale viene inserito.

Aluminium is synonymous of lightness, ductility and stability. We use this material mostly to assemble glazed fronts. In fact, aluminium is the best material to frame glass. Light yet sturdy, it is suitable for any type of machining process and offers unequalled assurance of stability. Traditionally employed in its natural shade, it is now available in colours that perfectly match the finish of the cabinet it is fitted on.



Carrara bianco cat. A
white Carrara cat. A



fior di pesco carnico grigio cat. B
fior di pesco carnico grigio cat. B

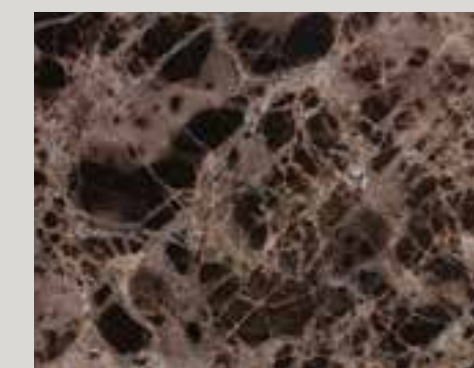

emperor dark cat. B
emperor dark cat. B



grafite cat. B
graphite cat. B



IL GRESS PORCELLANATO
porcelain stoneware

Il gress porcellanato presenta elevate caratteristiche di omogeneità e durezza (scala MOHS 8); è un materiale ottenuto con materie prime naturali quali argille e feldspati, colorate con pigmenti inorganici, completamente eco-compatibili e riciclabili al 100%.

I vantaggi di questo materiale sono molteplici:

- resiste ai solventi organici, disinfettanti e detergenti;
- si pulisce con estrema facilità mantenendo inalterate le sue proprietà;
- non contiene materiale organico, pertanto resiste al fuoco e alle alte temperature e in caso di incendio non sprigiona fumo e non emette sostanze tossiche;
- ha un assorbimento dell'acqua prossimo allo zero;
- resiste al gelo e si adatta a tutte le condizioni climatiche;
- resiste a graffi e all'abrasione profonda e le sue proprietà rimangono inalterate anche dopo uso intensivo e pulizia frequente;
- le lastre di porcellana laminata possono essere incollate con altri materiali, tagliate, sagomate, incise e bisellate allo scopo di soddisfare diverse esigenze;
- prive di pigmenti organici, i colori non subiscono alcuna variazione, resistendo ai raggi U.V. anche se sottoposti a condizioni climatiche estreme;
- presenta un elevato modulo di rottura.

Porcelain stoneware is very homogeneous and hard (8 on the MOHS scale) and is obtained from natural materials such as clays and feldspars coloured with non-organic pigments that are fully eco-compatible and recyclable. This materials offers many advantages:

- *it is resistant to organic solvents, disinfectants and detergents;*
- *it is very easy to clean while preserving its properties unaltered;*
- *it does not contain organic material which makes it fireproof and resistant to high temperatures. In the event of fire it does not produce smoke or toxic substances;*
- *its water absorption capacity is close to zero;*
- *it is frostproof and adapts to all weather conditions;*
- *it is scratch and abrasion resistant and preserves its properties even after intense use and frequent cleaning;*
- *sheets of laminated porcelain can be glued to other materials, cut, shaped, engraved and bevelled to meet various requirements;*
- *since it contains no organic pigments it is colourfast and resistant to UV rays even under extreme weather conditions;*
- *it has a high breaking load.*

CERAMICA
EFFETTO MARMO
marble effect ceramic



Extrawhite



Blue de savoie

CERAMICA
EFFETTO PIETRA LAVICA
lava stone effect ceramic

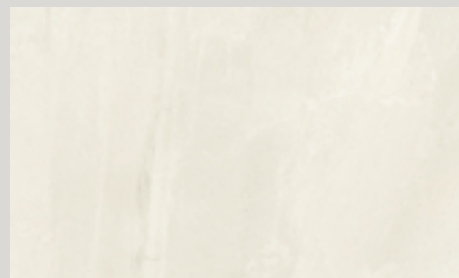

Pearl



Black

CERAMICA
EFFETTO METALLO
metal effect ceramic



White

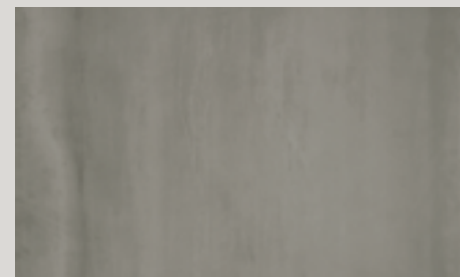

Grey



I MOOD - moods

18
INDUSTRIAL
Industrial

76
BORGHESE
Refined

142
NORDICO
Scandinavian

184
GLAMOUR
Glamorous

LO STILE INDUSTRIALE *the industrial style*



Lo stile industriale è caratterizzato dai materiali impiegati nella costruzione dei primi stabilimenti industriali. In questi ambienti, le strutture erano costituite da travi in acciaio, scale a vista in ferro, porte incardinate su vistose cerniere, corpi illuminanti a parabola, pareti grigliate, scaffalature metalliche, condutture in rame, finiture in ottone, contenitori in legno massiccio. La matericità di questi componenti ha un fascino particolare, in grado di trasmettere sensazioni visive e tattili tipiche di materiali 'poveri' ma allo stesso tempo funzionali che si trasformano in elementi di arredo.

The industrial style features materials used to make the first industrial buildings. The structures of these constructions were made of steel beams, exposed iron staircases, doors on showy hinges, dome lampshades, grid windows, metal shelving, copper piping, brass trims and solid wood containers. All these items have particularly fascinating textures capable of transmitting visual and tactile sensations typical of basic yet functional materials that become pieces of furniture.



I MOOD - *moods*

INDU- STRIAL



I MATERIALI DELLO STILE INDUSTRIALE

the materials typical of the industrial style.



Lo stile industriale è caratterizzato dai materiali impiegati nella costruzione dei primi stabilimenti industriali.

In questi ambienti, le strutture erano costituite da travi in acciaio, scale a vista in ferro, porte incardinate su vistose cerniere, corpi illuminanti a parabola, pareti grigliate, scaffalature metalliche, condutture in rame, finiture in ottone, contenitori in legno massiccio.

La matericità di questi componenti ha un fascino particolare, in grado di trasmettere sensazioni visive e tattili tipiche di materiali "poveri" ma allo stesso tempo funzionali che si trasformano in elementi di arredo.

The industrial style features materials used to make the first industrial buildings.

The structures of these constructions were made of steel beams, exposed iron staircases, doors on showy hinges, dome lampshades, grid windows, metal shelving, copper piping, brass trims and solid wood containers.

All these items have particularly fascinating textures capable of transmitting visual and tactile sensations typical of basic yet functional materials that become pieces of furniture.

Acciaio per le strutture dei complementi, legno invecchiato per i pannelli e maniglie in metallo invecchiato: elementi caratterizzanti che riescono ad imprimere alla cucina ispirata a questo stile una particolare connotazione.

Ed è proprio attraverso la rivisitazione in chiave moderna dello stile industriale che l'arredo è in grado di far rivivere l'emozione di un tempo passato.

Steel is used for accessory frames, distressed wood for panels and distressed metal for handles: these distinctive elements give the kitchens inspired by this style a very special appeal.

Thanks to our renovated, modern version of the industrial style, furniture can once again stimulate the emotions conveyed in bygone days.



 **INDUSTRIAL 1**
INDUSTRIAL 1

Anta: modello Eta
Finitura: Laccato grafite opaco
Top lavica black
Particolari in Natural Wood noce canaletto

Doors: Eta model
Finish: Matt Grafite lacquer
Lavica black worktop
Black walnut Natural Wood details









Madia finitura natural wood noce canaletto con boiserie bianco venato extra e mensole in plexiglass impiallacciato noce canaletto retroilluminate.

Black walnut Natural Wood finish sideboard with Bianco Venato Extra wall panelling and black walnut veneered backlit Plexiglas shelves.





Anta Eta in finitura natural wood rovere vintage. Particolari in laccato grafite opaco, ripiani telaio alluminio finitura grafite opaco e vetro trasparente.

Eta door with a vintage oak Natural Wood finish. Matt Grafite lacquered details, shelves in transparent glass with matt Grafite finish aluminium frames.





36

Proposta living finitura natural wood rovere vintage, laccato grafite opaco, vetrine con telaio alluminio grafite e vetro trasparente.

Living room layout in vintage oak Natural Wood and matt Grafite lacquer. Glazed doors with Grafite aluminium frames and transparent glass.



37





SCHEDA TECNICA
INDUSTRIAL 1
Technical information
Industrial 1

ANTA
 Door



ETA

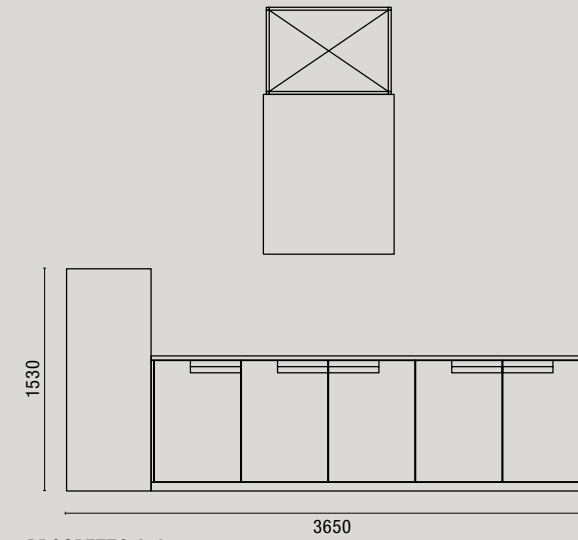

PROSPETTO A-A
 Front view A-A

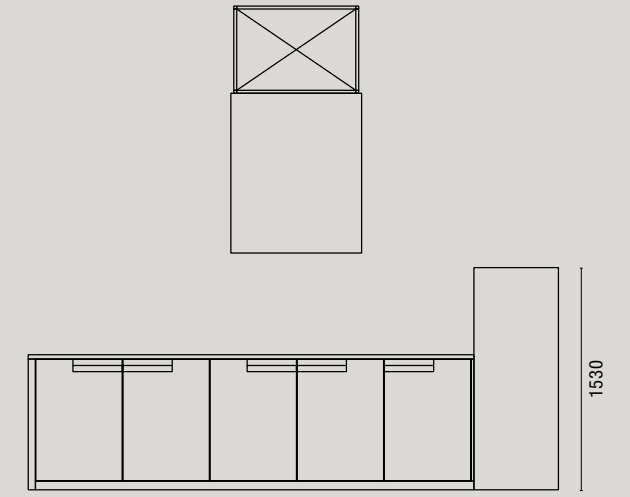

PROSPETTO B-B
 Front view B-B

FINITURE UTILIZZATE
 Finishes used



Solid Wood Noce Canaletto
 Black walnut solid wood



Laccato Grafite Opaco
 Matt Grafite lacquer



Top Lavica Black
 Lavica Black worktop

VISTA IN PIANTA
 Plan

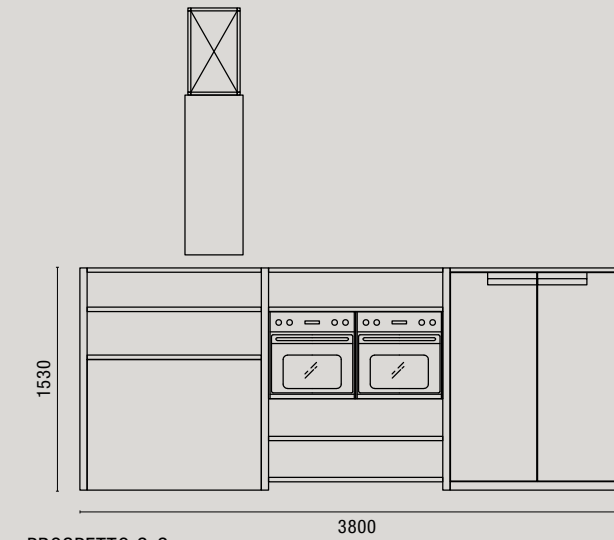
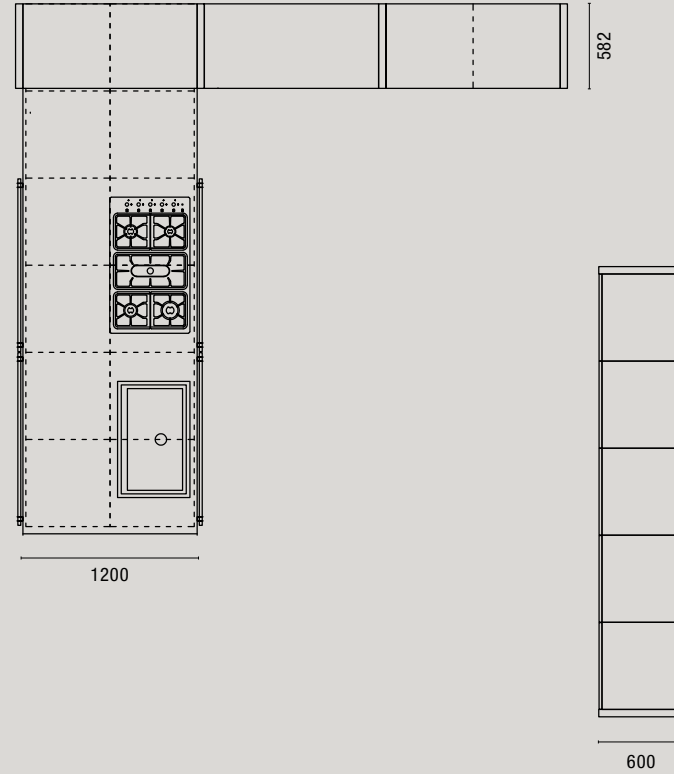

PROSPETTO C-C
 Front view C-C

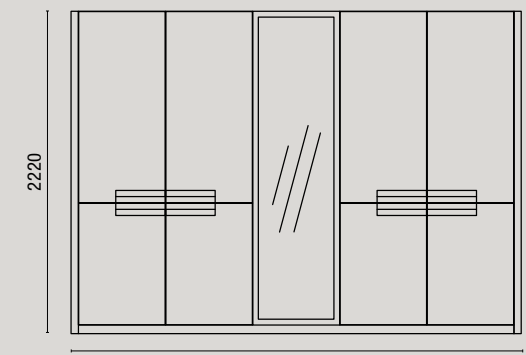

PROSPETTO D-D
 Front view D-D

 **INDUSTRIAL 2**
INDUSTRIAL 2

Anta: modello Beta
Finitura: Natural Wood Rovere Nodato
 Natural Wood Rovere Vintage con Intarsio
 Laccato Grafite Opaco
 Top Metal XXL Black

Doors: Beta model
Finish: Knotted oak Natural Wood
 Vintage oak Natural Wood with engravings.
 Matt Grafite lacquer
 Metal XXL Black worktop







Cassetti interni in legno massello con guide ad estrazione totale ed attrezzatura interne.

Interior drawers made of solid wood with full-extension runners and inserts.





Vetrine telaio alluminio finitura grafite, con vetro fumè e retroilluminazione a led laterale. Ripiani interni con telaio alluminio finitura grafite e vetro trasparente.

Glazed doors with Grafite finish aluminium frames, smoked glass and led lighting on the rear side. The transparent glass interior shelves have Grafite finish aluminium frames.





Bancone snack in legno massello finitura rovere nodato.

Breakfast bar in knotted oak finish solid wood.







SCHEMA TECNICA
INDUSTRIAL 2
Technical information
Industrial 2

ANTA
 Door



BETA

ANTA
 Door



HET

MANIGLIA
 Handles



EKO

VISTA IN PIANTA
 Plan

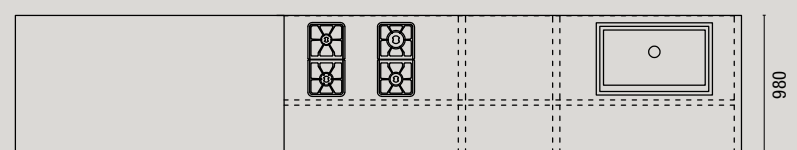

FINITURE UTILIZZATE
 Finishes used



Natural Wood Rovere Nodato
 Knotted oak Natural Wood



Natural Wood Rovere Vintage con Intarsio
 Vintage oak Natural Wood with engravings

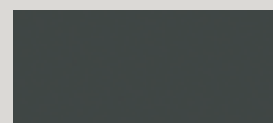

Laccato Grafite Opaco
 Matt Grafite lacquer

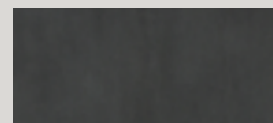

Top Metal XXL Black
 Metal XXL Black worktop

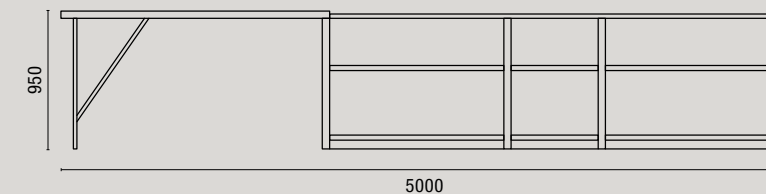

PROSPETTO A-A
 Front view A-A

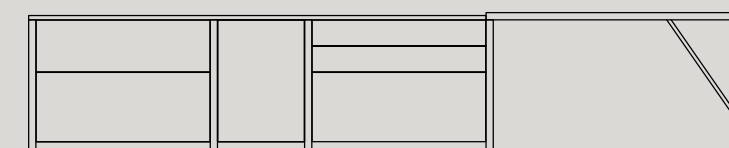

PROSPETTO B-B
 Front view B-B

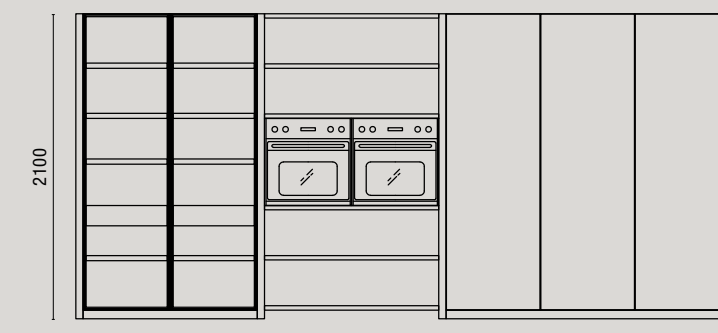

PROSPETTO C-C
 Front view C-C

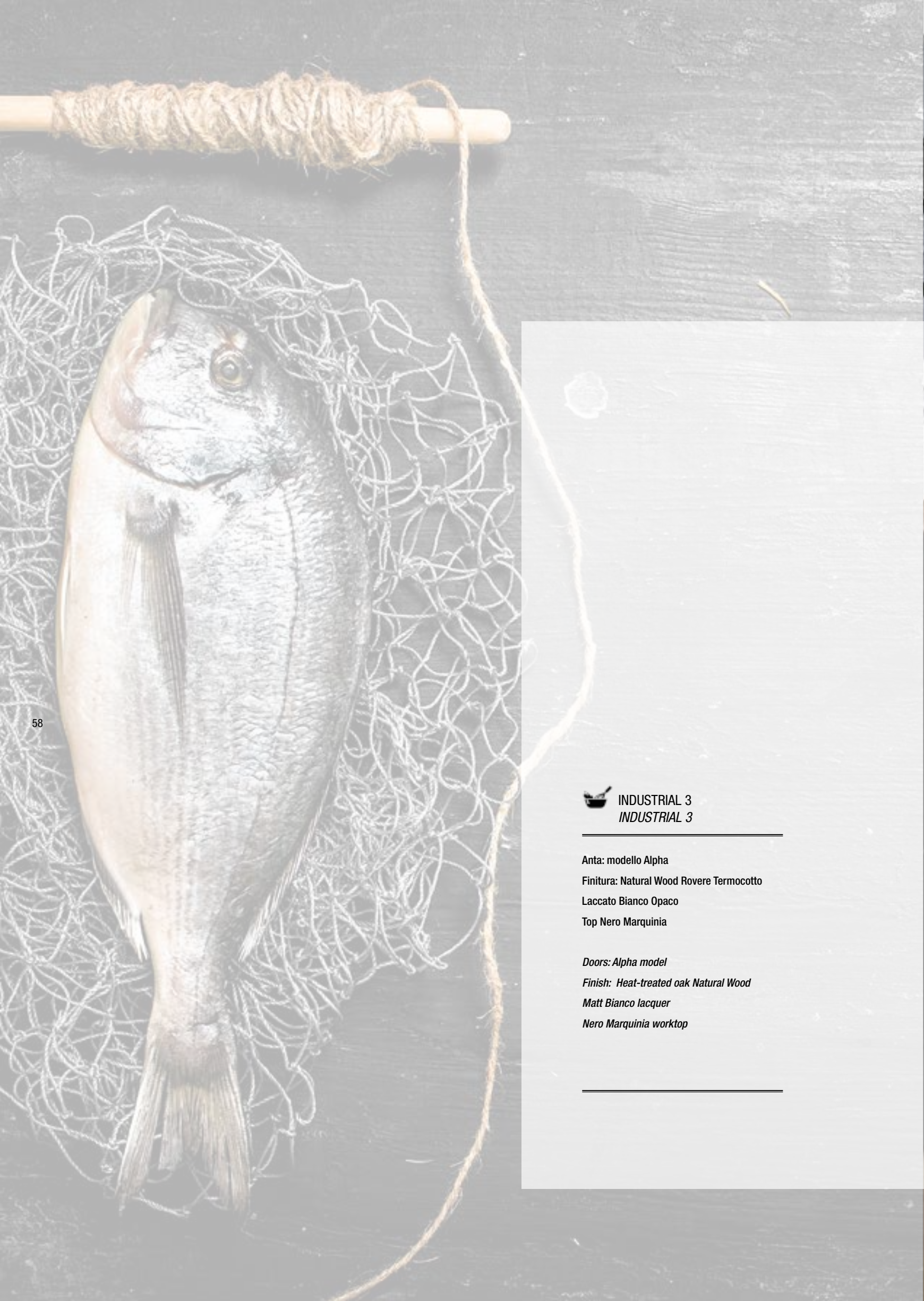

 **INDUSTRIAL 3**
INDUSTRIAL 3

Anta: modello Alpha
Finitura: Natural Wood Rovere Termocotto
Laccato Bianco Opaco
Top Nero Marquinia

Doors: Alpha model
Finish: Heat-treated oak Natural Wood
Matt Bianco lacquer
Nero Marquinia worktop







Bancone snack in legno massello finitura rovere termocotto.
Old Line fornisce più tipologie di movimento per tavoli e banconi snack.

Breakfast bar in heat-treated oak finish solid wood. Various table and breakfast bar configurations are available.







Cucina con gola e zoccolo in finitura grigio grafite e vano laterale libreria.

Kitchen with a Grigio Grafite finish handleless channel and plinth and an open shelving unit on the side.











SCHEDA TECNICA
INDUSTRIAL 3
Technical information
Industrial 3

ANTA
 Door



ALPHA

FINITURE UTILIZZATE
Finishes used



Natural Wood Rovere Termocotto
 Heat-treated oak Natural Wood

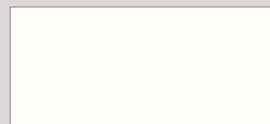

Laccato Bianco Opaco
 Matt Bianco lacquer



Top Nero Marquinia
 Nero Marquinia worktop

VISTA IN PIANTA
 Plan

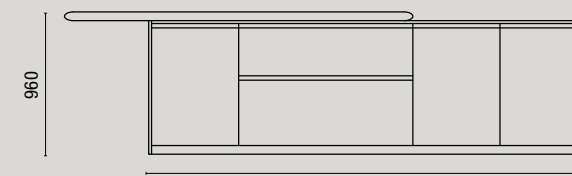
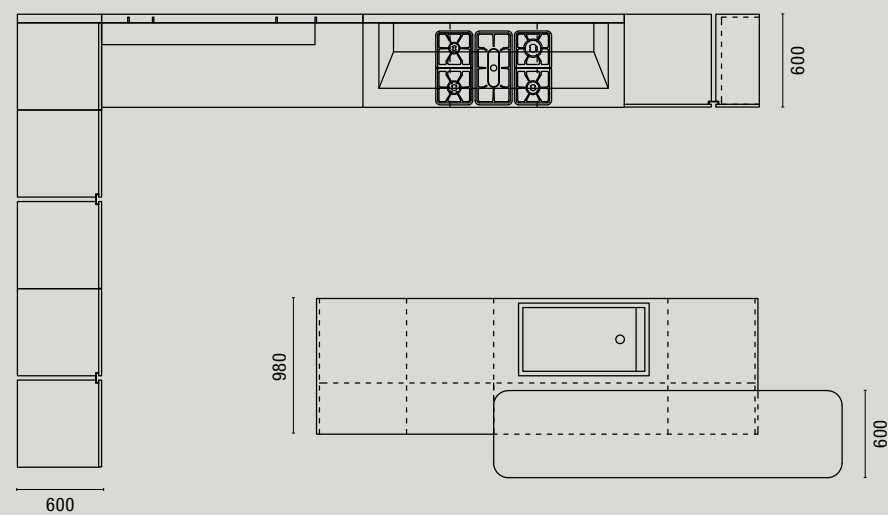

PROSPETTO A-A
 Front view A-A

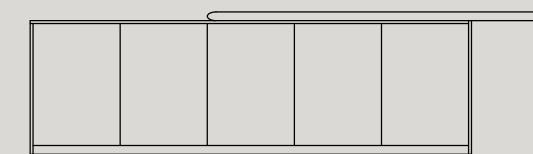

PROSPETTO B-B
 Front view B-B

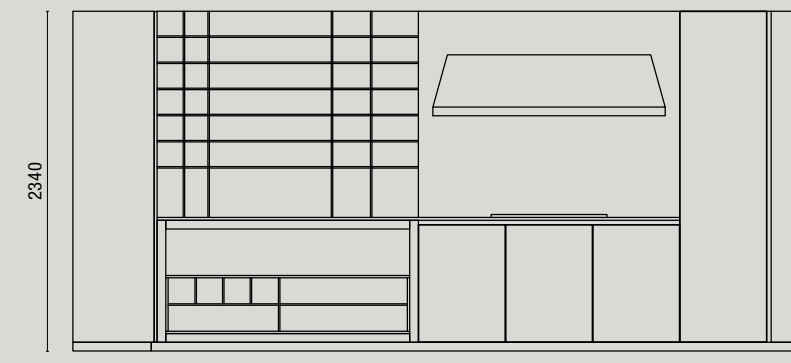

PROSPETTO C-C
 Front view C-C

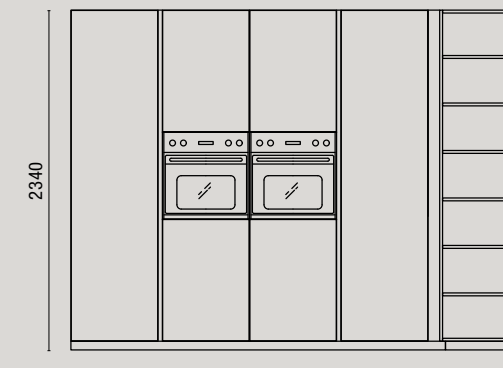

PROSPETTO D-D
 Front view D-D

LO STILE BORGHESE

The refined style



Lo stile borghese, ovvero lo stile dell'agiatezza e del buon gusto, spesso associato ad un ceto amante della comodità e del benessere. Preziosità delle finiture ed ambienti ricchi di dettagli architettonici, fanno di questo stile l'icona di un 'modus vivendi' calato in una realtà familiare in cui la casa viene vissuta come l'ambiente accogliente e caldo nel quale ricevere i propri amici, per condividere con loro momenti lieti attornati da arredi che infondono tranquillità e sicurezza.

The refined style reflects the good taste of those who don't have to count their pennies and love comfort and well-being. Refined finishes and rooms full of architectural details are distinctive of this style which represents a way of life for families looking to live in a warm, inviting home where friends can be welcomed to share happy moments surrounded by furniture that conveys a feeling of serene security.



I MOOD - moods

BOR-
GHESE

I MATERIALI DELLO STILE BORGHESE

The materials typical of the refined style.

L'identificazione dello stile borghese passa attraverso l'uso di materiali quali marmo, boiserie, divani in pelle, tappeti d'epoca, tessuti preziosi, cristalli, specchi, finiture in ottone.

La casa arredata in questo stile rappresenta una dimora dal gusto classicheggiante, in cui ogni spazio diventa un angolo esclusivo che assolve la sua peculiare funzione in un clima di amenità.

Anche nella cucina ritroviamo questi materiali, dal marmo dei top al legno dei frontali, dai vetri delle mensole al metallo antichizzato delle maniglie.

The refined style is represented by materials such as marble, wainscoting, leather sofas, period carpets and rugs, precious fabrics, crystal ware, mirrors and brass trims.

Homes furnished with this style have a classic appeal and every space becomes exclusive while serving its purpose in a way that creates a delightful atmosphere.

These materials can also be found in the kitchen: marble worktops and wooden fronts, glass shelves and distressed metal for the handles.

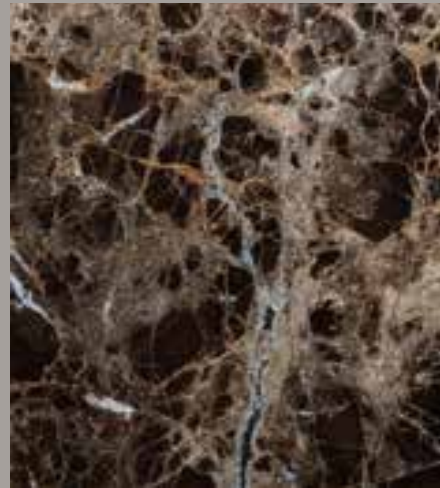

Nella casa arredata in stile borghese, tutto parla di agiatezza, di comfort, di gusto e di ricercatezza con finiture che esprimono uno stile di vita.

Homes furnished in a refined style reflect the good life of the well-to-do: comfort, good taste, elegance and finishes that express a way of life.





 **BORGHESE 1**
REFINED 1

Anta: modello Alpha e modello Prestige
Finitura: Solid Wood Noce Canaletto
Laccato: Bianco Opaco
Top: Blue de Savoie

Doors: Alpha model and Prestige model
Finish: Black walnut solid wood
Matt: Bianco lacquer
Blue de Savoie worktop





Parete divisoria predisposta per creare un accesso facilitato alla cantina.

Partition units designed for easy access to the wine cellar.



84



85



Cantina attrezzata con illuminazione led, portabottiglie e cassetto vassoio.

Wine cellar with led lighting, bottle racks and drawers.









SCHEMA TECNICA
BORGHESE 1
Technical information
Refined 1

ANTA
Door



ALPHA

ANTA
Door



PRESTIGE

FINITURE UTILIZZATE
Finishes used



Solid Wood Noce Canaletto
 Black walnut solid wood

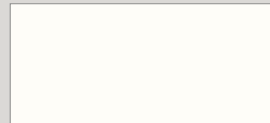

Laccato Bianco Opaco
 Matt Bianco lacquer

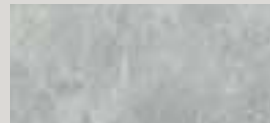

Top Blue de Savoie
 Blue de Savoie worktop

VISTA IN PIANTA
Plan

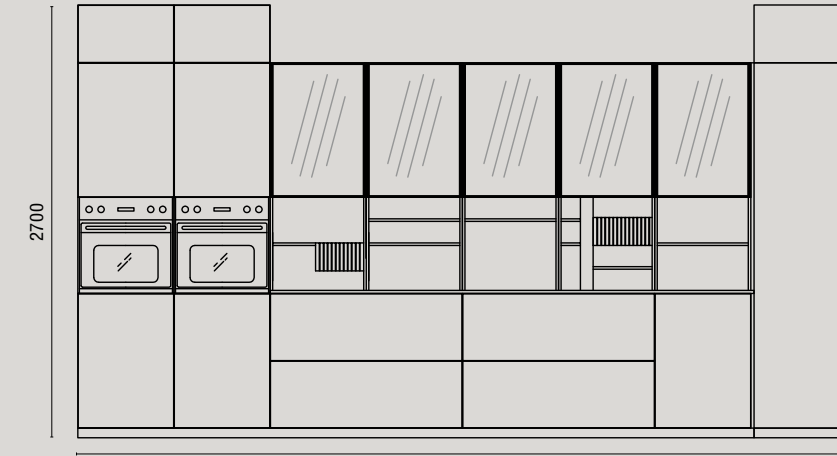
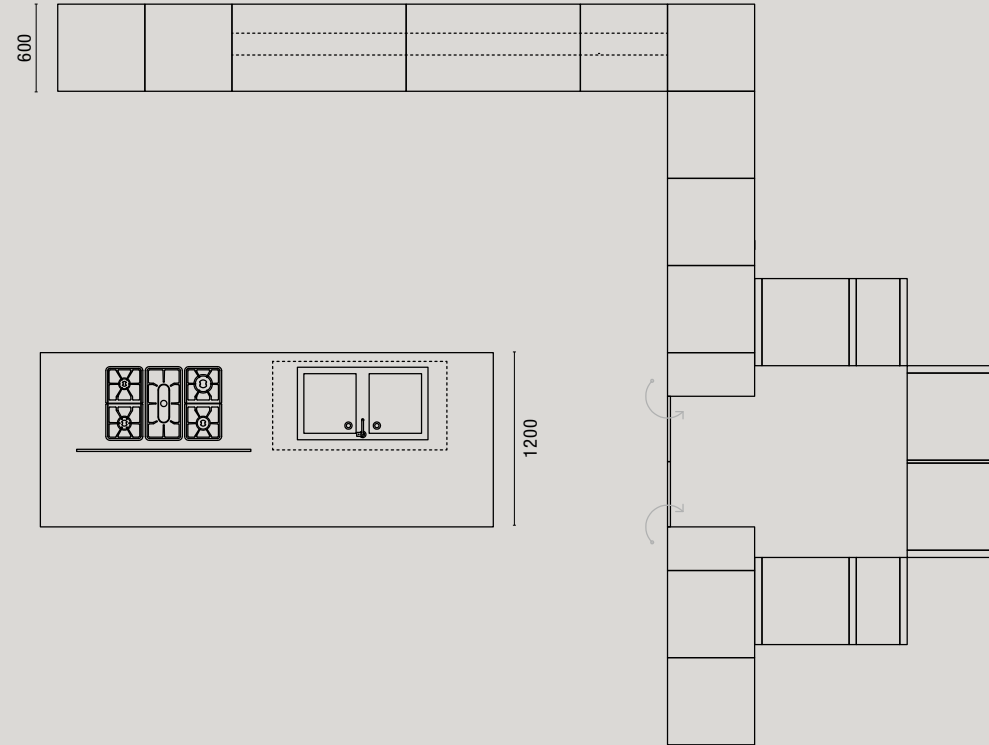

PROSPETTO A-A
Front view A-A

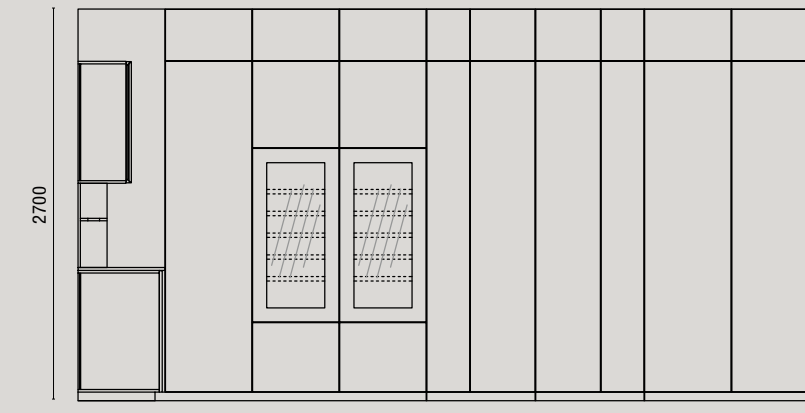

PROSPETTO B-B
Front view B-B

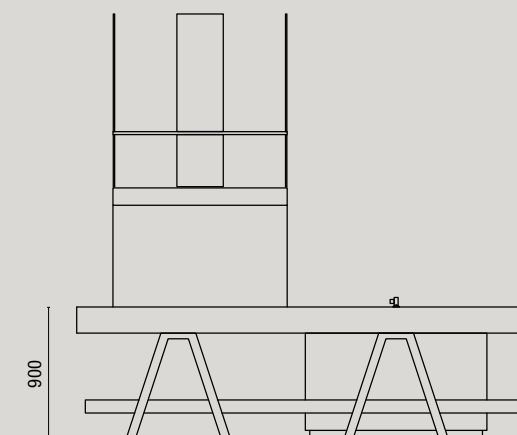

PROSPETTO C-C
Front view C-C

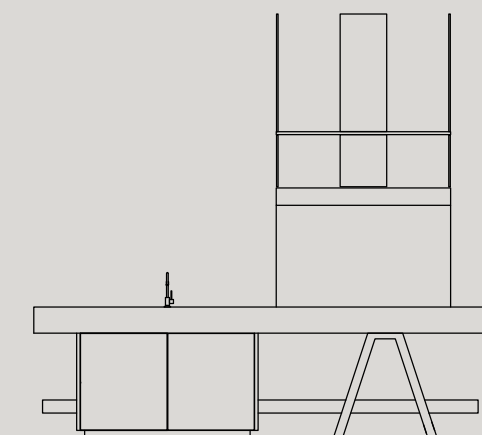

PROSPETTO D-D
Front view D-D

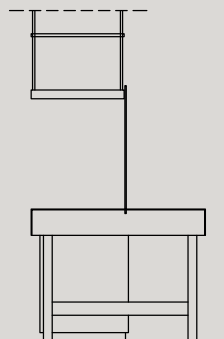

PROSPETTO E-E
Front view E-E



 BORGHESE 2
REFINED 2

Anta: modello Alpha
Finitura: Natural Wood Rovere Termocotto
Top Marmo Carrara Bianco

Doors: Alpha model
Finish: Heat-treated oak Natural Wood
White Carrara marble worktop







98

Isola in marmo carrara bianco con fuochi integrati e tagliere in massello noce canaletto.

Island in white Carrara marble with integrated hob and solid black walnut chopping board.



99

Elemento contenitore a giorno con cassetti in massello, unione a pettine, bicolore.

Two-toned open unit with finger-jointed solid wood drawers.











Tavolo massello rovere con piano in marmo carrara bianco.

Solid oak table with white Carrara marble top.





SCHEMA TECNICA
BORGHESE 2
Technical information
Refined 2

ANTA
 Door



ALPHA

MANIGLIA
 Handle



COLIBRI

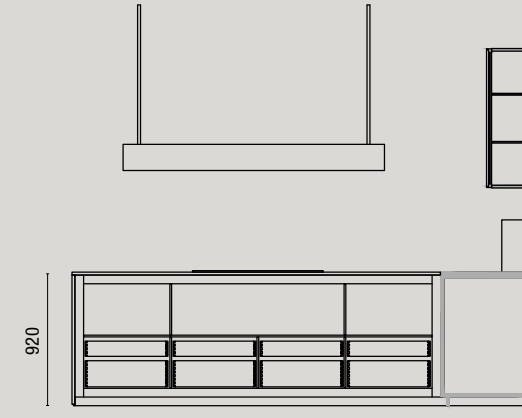

PROSPETTO A-A
 Front view A-A

3140

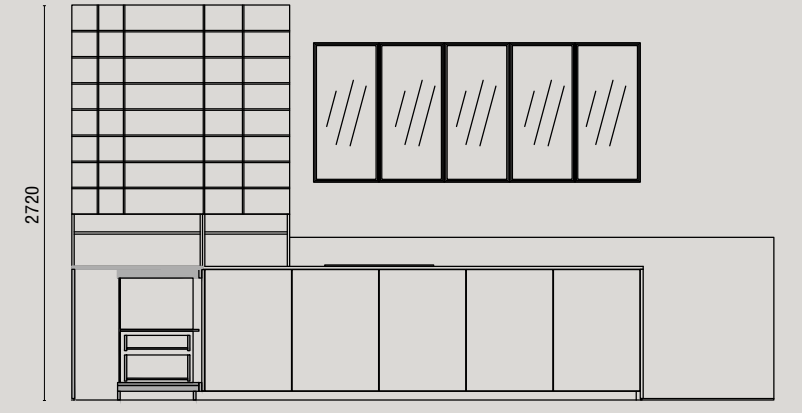

PROSPETTO B-B
 Front view B-B

4820

VISTA IN PIANTA
 Plan

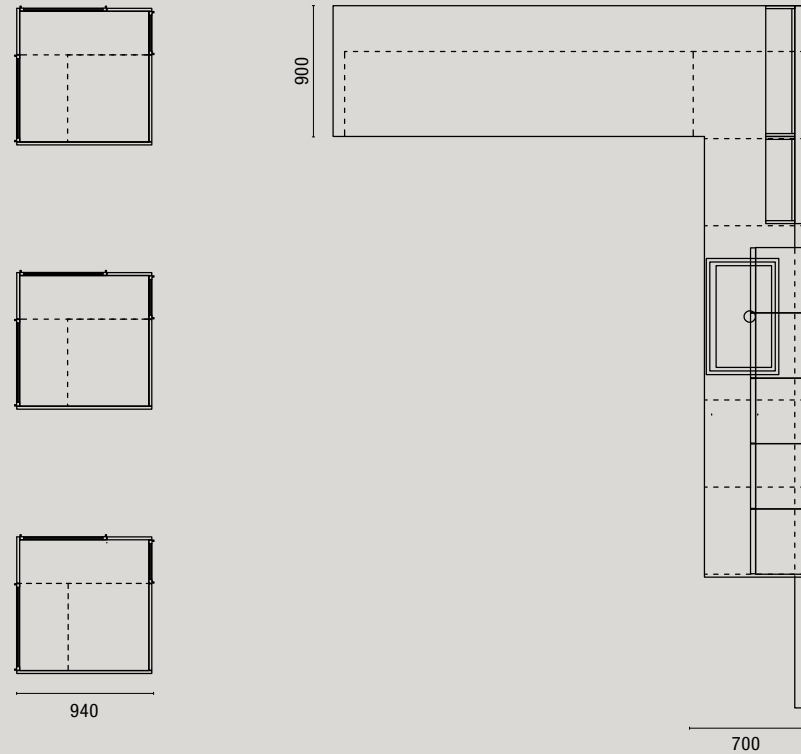

900

940

700

FINITURE UTILIZZATE
 Finishes used



Natural Wood Rovere Termocotto
 Heat-treated oak Natural Wood



Top Marmo Carrara Bianco
 White Carrara marble worktop

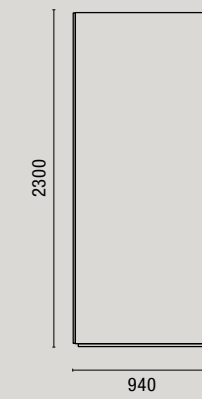

PROSPETTO C-C
 Front view C-C

940

2300

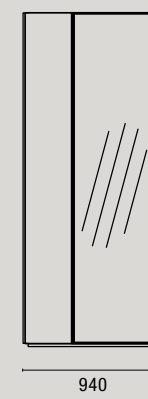

PROSPETTO F-F
 Front view F-F

940

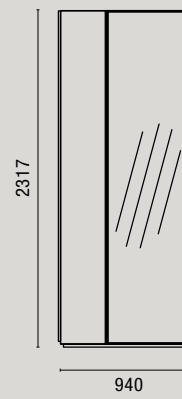

PROSPETTO E-E
 Front view E-E

940

2317

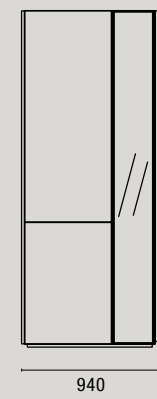

PROSPETTO D-D
 Front view D-D

940

 **BORGHESE 3**
REFINED 3

Anta: modello Alpha e modello Eta
Finitura: Natural Wood Olmo
Laccato: Perla Opaco
Top: Acciaio

Doors: Alpha model and Eta model
Finish: Elm Natural Wood
Matt Perla lacquer
Stainless steel worktop





Isola con fianchi e top in acciaio. I fuochi sono integrati al top e i comandi sono posti sulla parte frontale.

Island with stainless steel sides and top. The hob is integrated in the worktop and the controls are at the front.



Top con canale attrezzato, porta coltelli e sottopentole in acciaio.

Worktop with accessorised channel, knife-rack and pot stand.





Top in acciaio, lavello integrato, porta coltelli in finitura legno.



Stainless steel worktop with integrated sink, wood finish knife block.





SCHEDA TECNICA
BORGHESE 3
Technical information
Refined 3

ANTA
 Door



ALPHA

ANTA
 Door



ETA

FINITURE UTILIZZATE
Finishes used

124



Natural Wood Olmo
 Elm Natural Wood

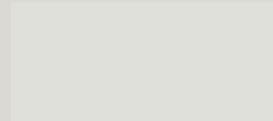

Laccato Perla Opaco
 Matt Perla lacquer

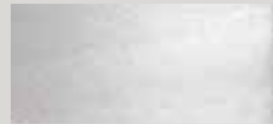

Top Acciaio
 Stainless steel worktop

VISTA IN PIANTA
Plan

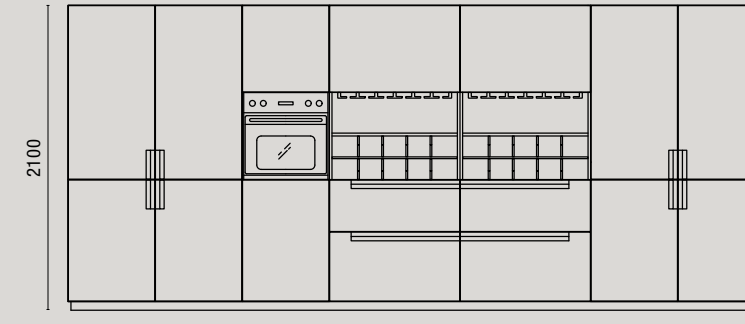
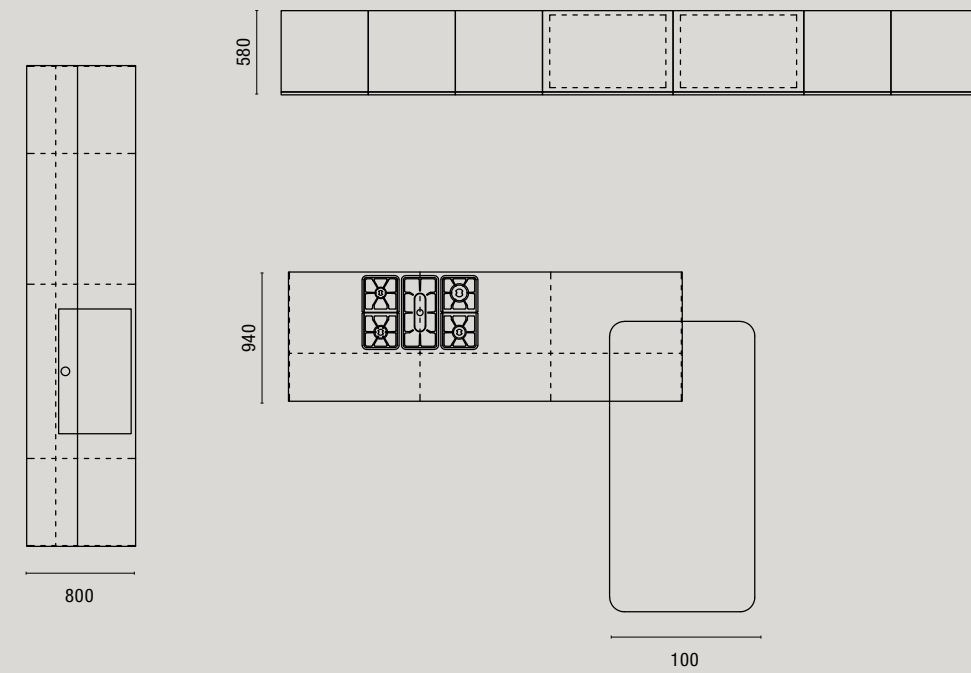

PROSPETTO A-A
Front view A-A

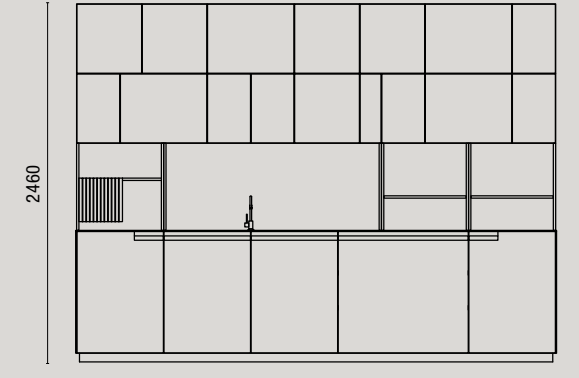

PROSPETTO D-D
Front view D-D

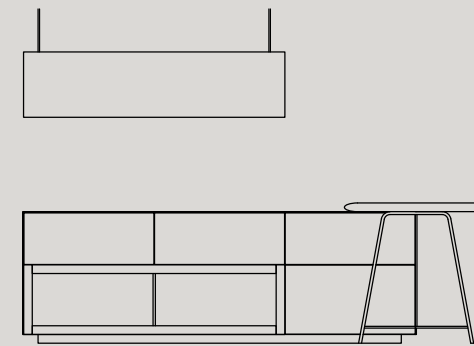

PROSPETTO C-C
Front view C-C

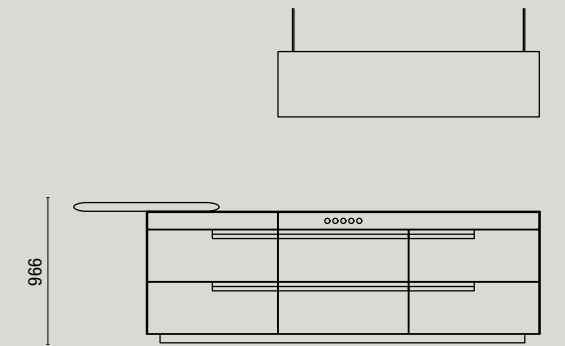

PROSPETTO B-B
Front view B-B

125

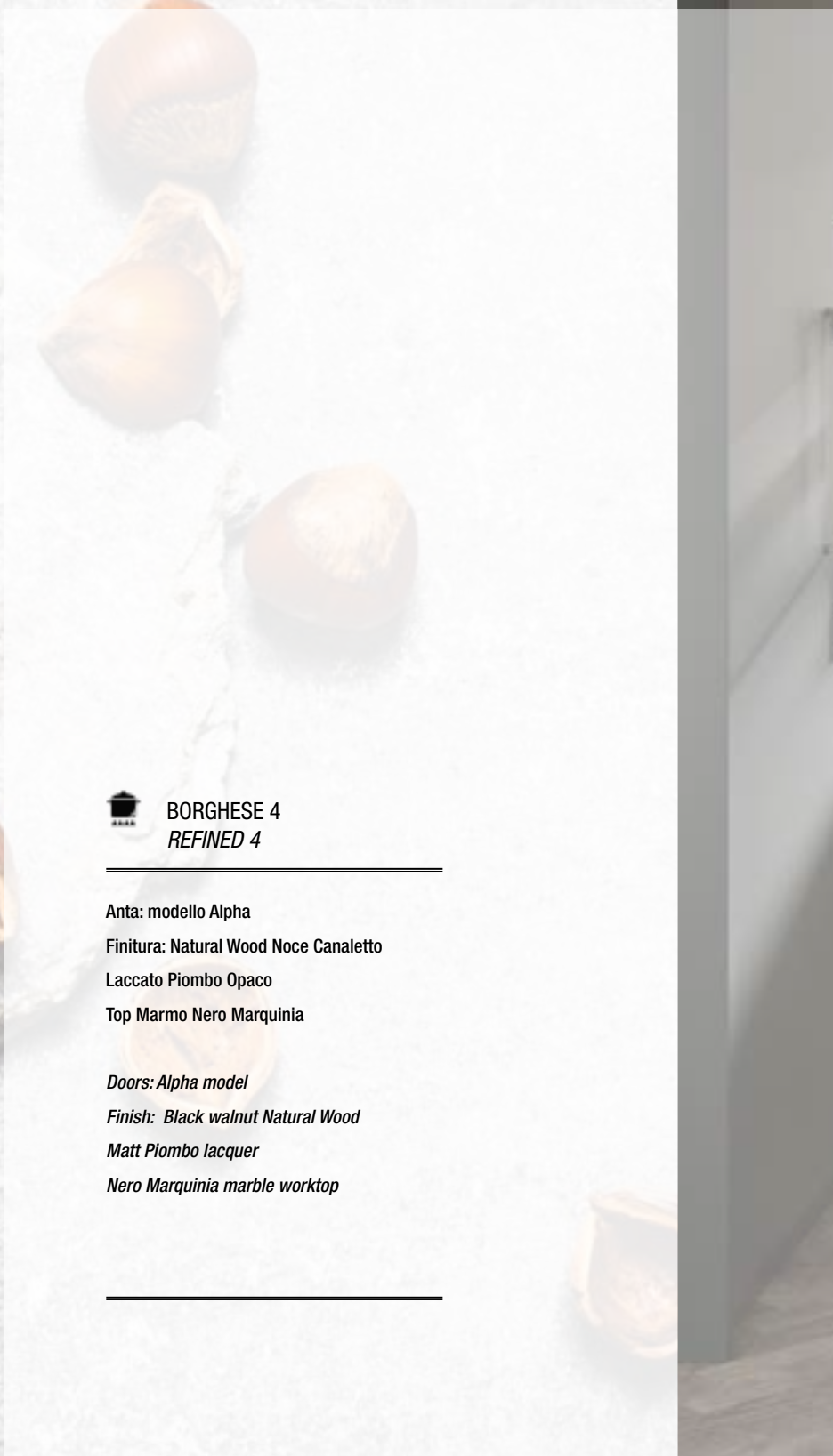

BORGHESE 4
REFINED 4

Anta: modello Alpha
Finitura: Natural Wood Noce Canaletto
Laccato: Piombo Opaco
Top: Marmo Nero Marquina

Doors: Alpha model
Finish: Black walnut Natural Wood
Matt Piombo lacquer
Nero Marquina marble worktop







Elemento vetrina con strutture massello, luce interna led, ante con telaio in alluminio grafite, vetro trasparente.

Glazed door display unit with a metal structure, interior led lights and transparent glass doors with Grafite aluminium frames.







Esempi di elementi contenitori a giorno, per mobili integrati cucina e madie, portabottiglie in massello e cassetti con unione a coda di rondine.

Examples of open shelving units used in kitchen cabinets and sideboards with solid wood bottle-racks and dovetail jointed drawers.









SCHEDA TECNICA
BORGHESE 4
Technical information
Refined 4

ANTA
 Door



ALPHA

MANIGLIA
 Handle



LINEA

FINITURE UTILIZZATE
Finishes used



Natural Wood Noce Canaletto
 Black walnut Natural Wood



Laccato Piombo Opaco
 Matt Piombo lacquer



Top Marmo Nero Marquina
 Nero Marquina marble worktop

VISTA IN PIANTA
Plan

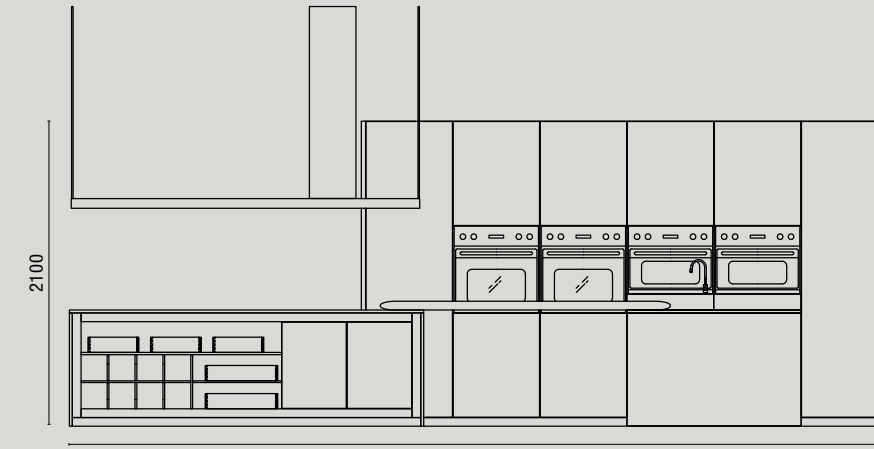
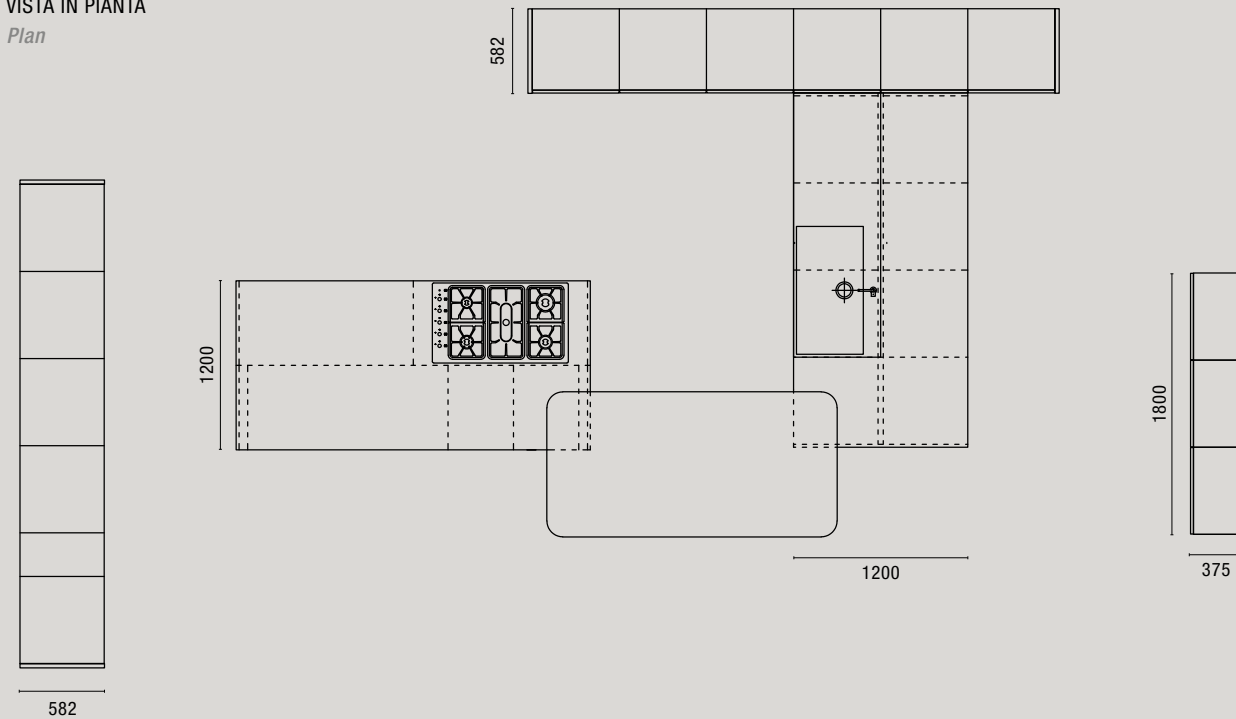

PROSPETTO A-A
 Front view A-A

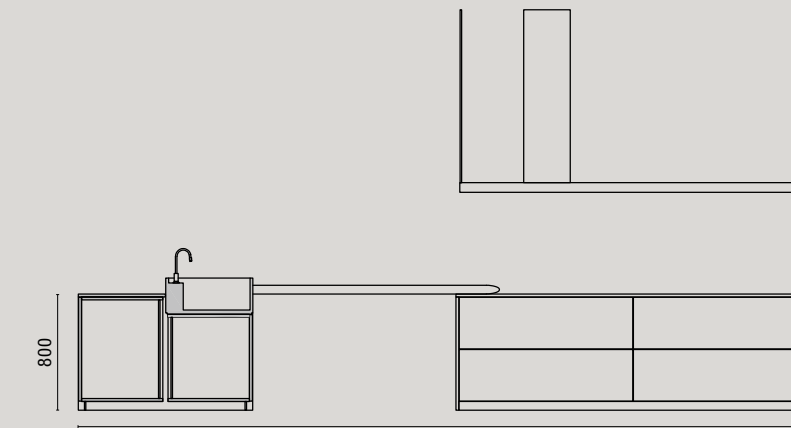

PROSPETTO B-B
 Front view B-B

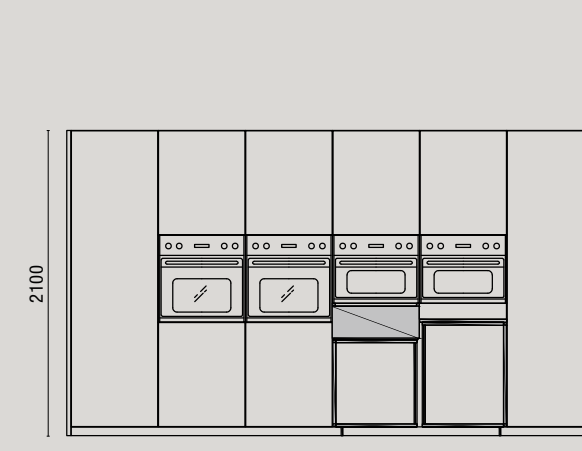

PROSPETTO D-D
 Front view D-D

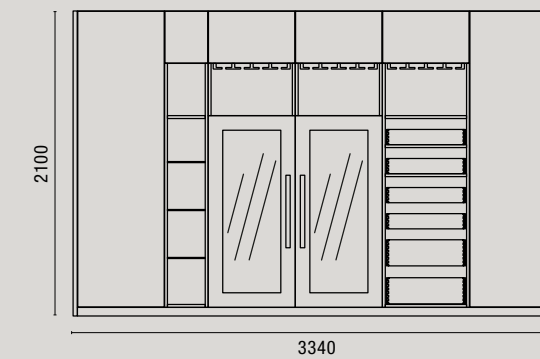

PROSPETTO F-F
 Front view F-F

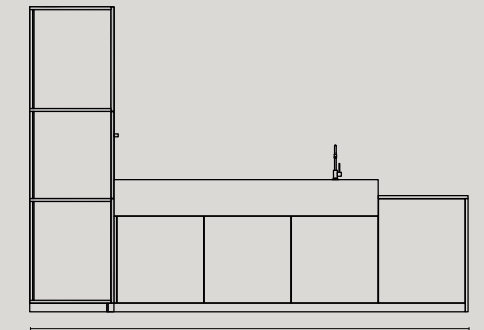

PROSPETTO C-C
 Front view C-C

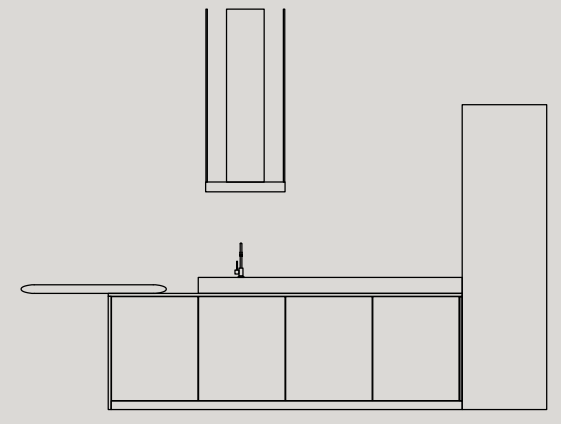

PROSPETTO E-E
 Front view E-E

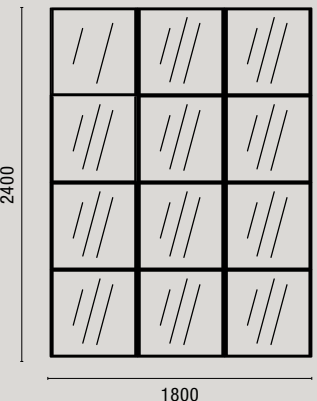

PROSPETTO G-G
 Front view G-G

LO STILE NORDICO *the scandinavian style*



Lo stile nordico, ovvero lo stile appartenente ai paesi del Nord Europa.

A quelle latitudini, la luce è un bene prezioso che viene 'catturato' dalle ampie vetrate degli edifici residenziali. Le estese e diffuse foreste forniscono inoltre il legname per l'edificazione di case in cui questa materia prima diventa un elemento imprescindibile per l'edilizia. Questi fattori sono bastanti da soli a delineare uno stile architettonico in cui il colore bianco predomina, intervallato dalle calde tinte di legni chiari e resinosi.

The Scandinavian style belongs to northern European countries.

At these latitudes light is a precious asset that is captured by the large windows of residential buildings. Extensive and widespread forests supply the timber needed to build houses in which wood is an essential ingredient. These aspects alone have sufficed to create a style of architecture in which white is the predominant colour interrupted by the warm tones of light-coloured, resinous wood species.



I MOOD - *moods*

NORDI- CO

I MATERIALI DELLO STILE NORDICO

*the materials typical of the
scandinavian style*

Stile nordico è soprattutto sinonimo di legno. Sterminate foreste di abeti ricoprono le terre del Nord Europa, fornendo da sempre il legname per l'impiego dello stesso nell'edilizia e nell'arredamento. Quest'uso promiscuo del legno, ha comportato una contaminazione tra architettura e arredamento. A volte, infatti, elementi architettonici quali scale o pareti, assumono l'aspetto di mobili proprio grazie all'impiego di materiali lignei. Nota comune è il colore chiaro delle essenze impiegate che si alternano in finiture naturali, laccate, o verniciate con velature che lasciano trasparire la venatura sottostante.

The Scandinavian style is foremost synonymous of wood. Endless fir tree forests cover northern Europe and have always supplied the timber required to build houses and furniture. This mixed usage of timber has resulted in architecture and furniture contaminating each other. Indeed, sometimes architectural elements such as staircases or walls take on the appearance of furniture because of the wood used. A common denominator is the light colour of the wood that can be found either with natural finishes, lacquered or lightly varnished to let the underlying grain show through.



Freschezza e luminosità degli ambienti, ispirati ad una naturalità che dall'esterno sembra propagarsi fino all'interno delle abitazioni, creando atmosfere che evocano la pace ed il silenzio delle grandi foreste.

Fresh, bright rooms inspired by the beauty of nature that seems to filter indoors from outside, creating atmospheres that induce a feeling of peace and bring to mind the silence of great forests.





 **NORDIC 1**
SCANDINAVIAN 1

Anta: modello Prestige
Finitura: Natural Wood Rovere Nodato
Laccato: Seta Opaco
Top Marmo: Arabescato
Top Legno: Massello Finitura Rovere Nodato

Doors: Prestige model
Finish: Knotted oak Natural Wood
Matt Seta: lacquer
Arabescato: marble worktop
Knotted Oak: finish solid wood worktop







Colonna a giorno portabottiglie con 2 cassetti contenitori. Isola con portabottiglie e capiente contenitore portagiaccio. (glassè)

Open tall unit with bottle-racks and 2 drawers. Island with countertop bottle stand and roomy ice container.







SCHEMA TECNICA
NORDICO 1
Technical information
Scandinavian 1

FINITURE UTILIZZATE
Finishes used



Natural Wood Rovere Nodato
 Knotted oak Natural Wood

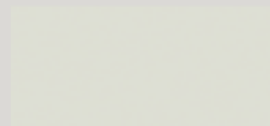

Laccato Seta Opaco
 Matt Seta lacquer



Top Marmo Arabescato
 Arabescato marble worktop



Top Legno Massello
 Finitura Rovere Nodato
 Solid wood worktop
 Knotted Oak finish

ANTA
Door



PRESTIGE

MANIGLIA
Handle



LAMA

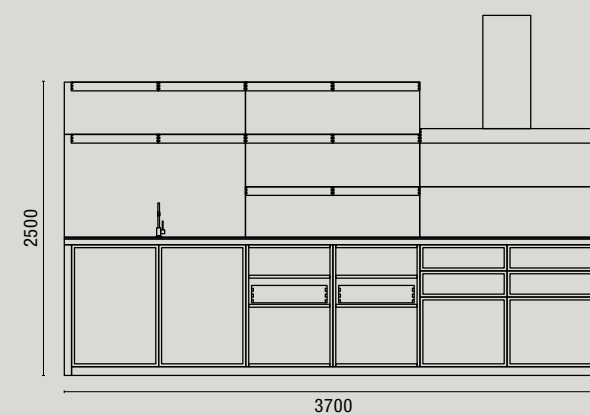

PROSPETTO A-A
Front view A-A

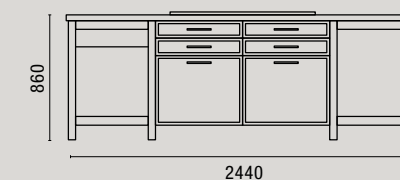

PROSPETTO B-B
Front view B-B

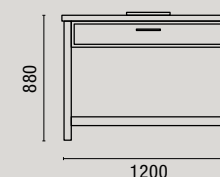

PROSPETTO C-C
Front view C-C

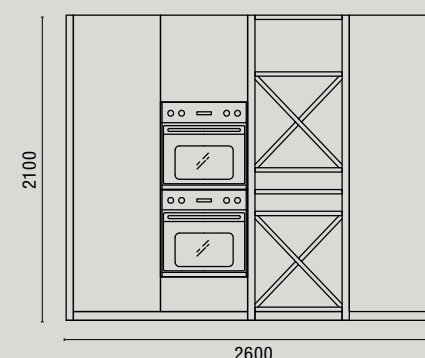

PROSPETTO E-E
Front view E-E

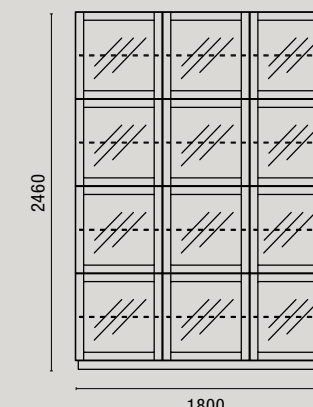

PROSPETTO D-D
Front view D-D

VISTA IN PIANTA
Plan

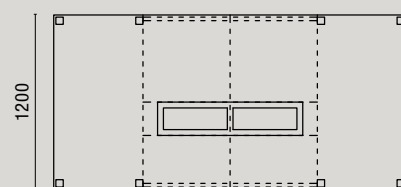
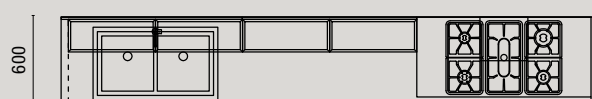



 **NORDIC 2**
SCANDINAVIAN 2

Anta: modello Beta
Finitura: Natural Wood Rovere Nodato
Laccato: Bianco Opaco
Laccato: Nuvola Opaco
Top: Marmo Carrara Bianco

Doors: Beta model
Finish: Knotted oak Natural Wood
Matt: Bianco lacquer
Matt: Nuvola lacquer
White: Carrara marble worktop







Elementi boiserie con schienali in rovere nodato e divisori laccati in finitura nuvola opaco.

Open shelving units with knotted oak back panels and matt Nuvola finish shelving panels.







SCHEMA TECNICA
NORDICO 2
Technical information
Scandinavian 2

ANTA
 Door



BETA

MANIGLIA
 Handle



COLIBRI

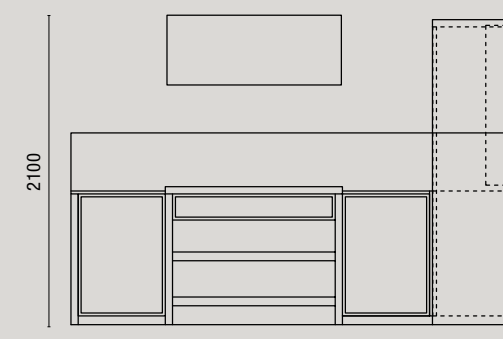

PROSPETTO A-A
 Front view A-A

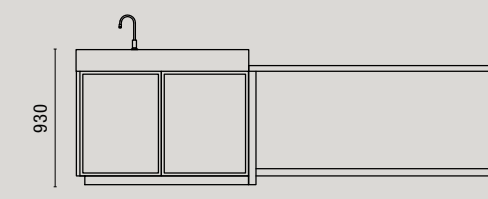

PROSPETTO B-B
 Front view B-B

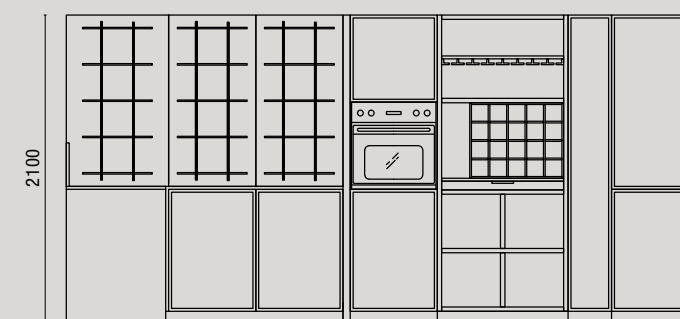

PROSPETTO C-C
 Front view C-C

VISTA IN PIANTA
 Plan

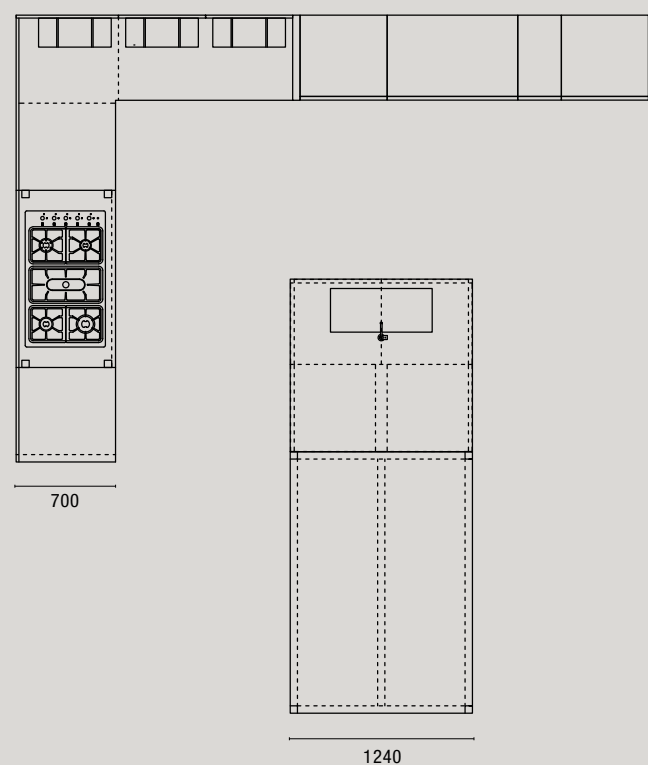

FINITURE UTILIZZATE
 Finishes used



Natural Wood Rovere Nodato
 Knotted oak Natural Wood



Laccato Bianco Opaco
 Matt Bianco lacquer



Laccato Nuvola Opaco
 Matt Nuvola lacquer



Top Marmo Carrara Bianco
 White Carrara marble worktop



 **NORDIC 3**
SCANDINAVIAN 3

Anta: modello Delta
Finitura: Natural Wood Rovere Nodato
Laccato: Fumo Opaco
Top: Marmo Carrara Bianco
Top Legno: Massello Finitura Rovere Nodato

Doors: Delta model
Finish: Knotted oak Natural Wood
Matt Fumo lacquer
White Carrara marble worktop
Knotted Oak finish solid wood worktop





Isola con piano cottura e cappa integrata
"BORA".
Mensole a giorno e elementi a vetrinetta
con vetrorete.

Island with integrated hob and BORA
extractor.
Open shelves and glass display units with
wire glass panels.



174



175





Lavello scavato in marmo carrara bianco, luci sottopensile a led.

White Carrara marble sculpted sink, under wall unit led lights.







SCHEMA TECNICA
NORDICO 3
Technical information
Scandinavian 3

ANTA
 Door



DELTA

MANIGLIA
 Handle



LAMA

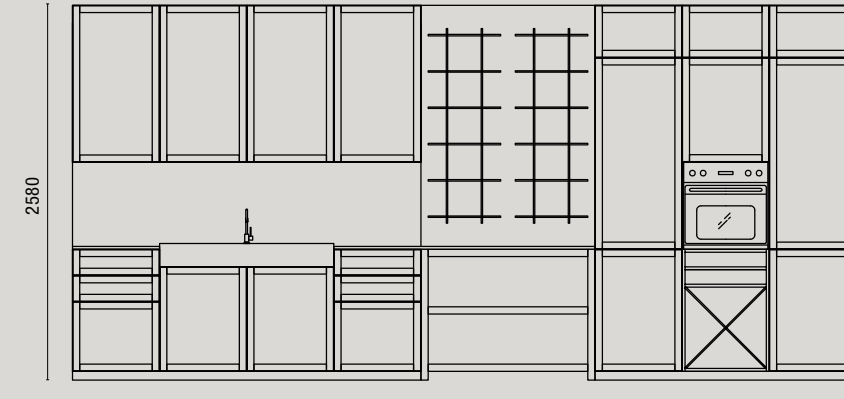

PROSPETTO A-A
 Front view A-A

5400

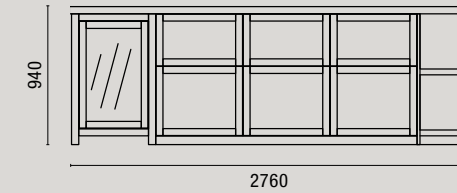

PROSPETTO B-B
 Front view B-B

2760

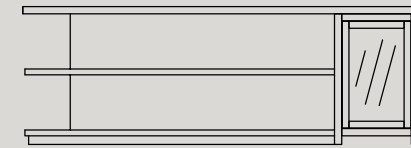

PROSPETTO C-C
 Front view C-C

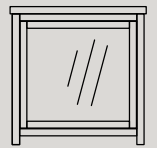

PROSPETTO D-D
 Front view D-D

940

VISTA IN PIANTA
 Plan

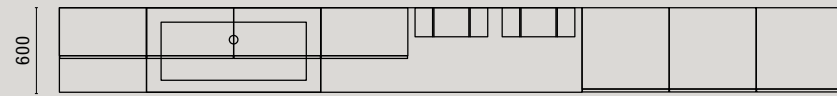

600

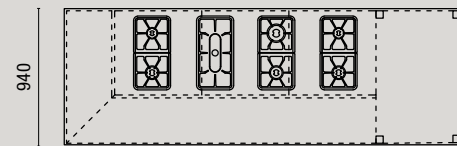

940

FINITURE UTILIZZATE
 Finishes used



Natural Wood Rovere Nodato
 Knotted oak Natural Wood

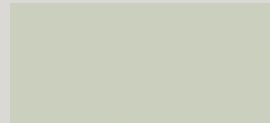

Laccato Fumo Opaco
 Matt Fumo lacquer

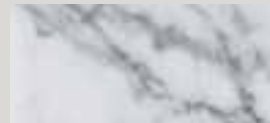

Top Marmo Carrara Bianco
 White Carrara marble worktop



Top Legno Massello
 Finitura Rovere Nodato
 Knotted Oak finish solid wood
 worktop

LO STILE GLAMOUR *the glamorous style*



Glamour, letteralmente "ricco di fascino". Uno stile urbano, in cui le contaminazioni di stili diversi si fondono e intrecciano. Richiami alle architetture dei primi del Novecento, accostamenti stilistici che ricordano le avanguardie del secolo scorso, "classicità" del design degli anni '50, modernità di arredi metropolitani nei quali si percepiscono echi di mode passate incalzati dalle nuove tendenze. Di ampia definizione, questo stile rappresenta a tutti gli effetti un crogiolo di espressioni caratterizzate soprattutto da modernità e mondanità, in un audace interpretazione di mode e di design.

Glamour literally means "full of charm". An urban style that mingles and blends different aesthetics. Hints of early 20th century architecture, styles reminiscent of the avant-garde movement of the 1900s, the "classicality" of the 50s all mingle with the modernity of metropolitan furniture which reflects the echoes of past fashions modified by new trends.

Although it can be defined in various ways, this style is, to all effects and purposes, a melting pot of modern and high society expressions blended with a bold interpretation of fashions and design.

184



I MOOD - moods

GLA- MOUR

185

I MATERIALI DELLO STILE GLAMOUR *the materials typical of the glamorous style.*

Coerentemente alla poliedricità dello stile Glamour, i materiali che lo caratterizzano ne riflettono canoni e tendenze.

Dettagli cromati che richiamano il design della metà del secolo scorso, finiture in ottone dei primi del novecento, marmo, pelle, intrecci metallici che ricordano l'art-déco, contrasti di colore accostabili a quadri di Mondrian, forme complesse ed astratte che rievocano sculture moderne. La materia al servizio del design, un delicato equilibrio di componenti dal quale prendono forma ambienti opulenti, in cui ogni dettaglio diventa complementare per la riuscita dell'insieme.

The materials that represent the Glamorous line are perfectly consistent with its rules and trends.

Chromed details reminiscent of the 50s; brass trims that take you back to the beginning of the 20th century; marble, leather and metal work typical of the art deco style; contrasting colours that remind one of a Mondrian painting and complex, abstract forms that look like modern sculptures.

Materials at the service of design, a delicate balance of parts that together make up luxurious layouts in which every detail is an essential complement to the success of the whole arrangement.



Accostamenti dosati sapientemente che danno vita ad un arredamento che riesce ad evocare sensazioni artistiche e stilistiche di grande effetto.

Cleverly combined pieces create settings that evoke very impressive artistic and stylistic sensations.



GLAMOUR 1
GLAMOUROUS 1

Anta: modello Alpha e modello Gamma
Finitura: Noce Canaletto Rombo
Laccato: Corteccia Opaco
Top: Metal XXL Black

Doors: Alpha model and Gamma model
Finish: Rhombus Black Walnut
Matt: Corteccia lacquer
Metal: XXL Black worktop







Top in Metal XXL Black, piano cottura con cappa integrata "BORA", alzata con mensole portaoggetti.

Metal XXL Black, worktop, integrated hob and BORA extractor, countertop shelving.





Zona living finitura in noce canaletto
rombo con piano a vassoio.

Living room furniture with a Rhombus
black walnut finish and a recessed top.











SCHEMA TECNICA
GLAMOUR 1
Technical information
Glamorous 1

ANTA
Door



ALPHA

ANTA
Door



GAMMA

MANIGLIA
Handle



EKO

VISTA IN PIANTA
Plan

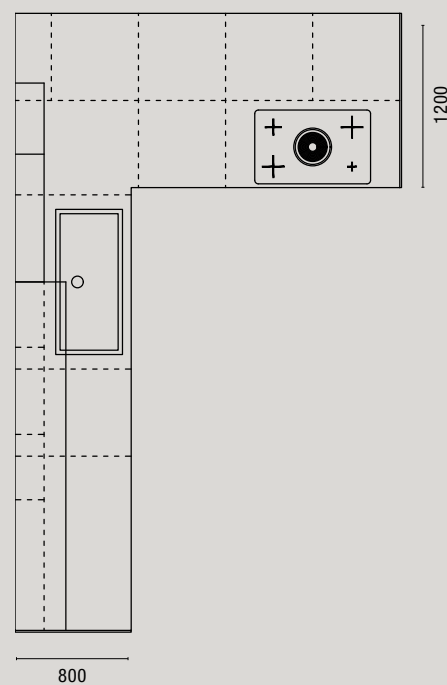
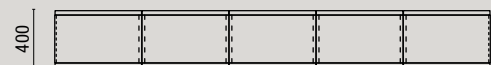

FINITURE UTILIZZATE
Finishes used

204



Noce Canaletto Rombo
Rhombus Black Walnut

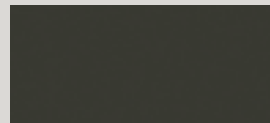

Laccato Cortecchia Opaco
Matt Cortecchia lacquer

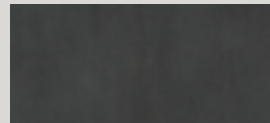

Top Metal XXL Black
Metal XXL Black worktop

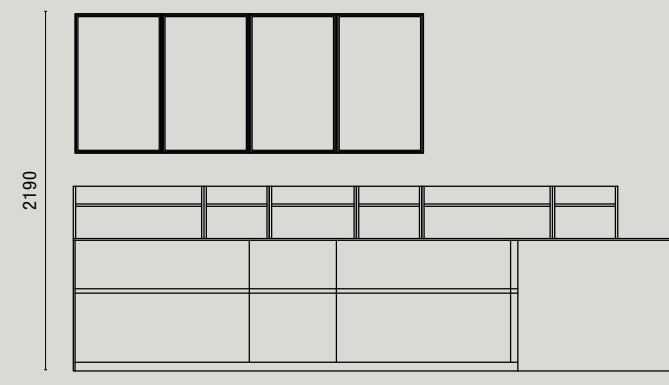

PROSPETTO B-B
Front view B-B

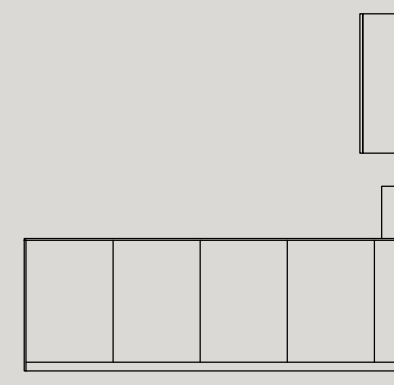

PROSPETTO A-A
Front view A-A



PROSPETTO C-C
Front view C-C

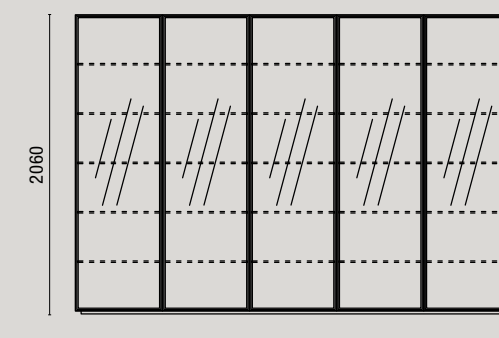

PROSPETTO D-D
Front view D-D

205



GLAMOUR 2
GLAMOUROUS 2

Anta: modello Delta
Finitura: Laccato Perla Lucido 60 Gloss
Top Marmo Arabescato

Doors: Delta model
Finish: 60 Gloss Perla lacquer
Arabescato marble worktop







Scolapiatti in finitura rombo laccato lucido con luce led sottopensile.

Gloss lacquered Rhombus finish dish-drainer unit with under wall unit led lights.





Penisola di forma esagonale, con basamento in finitura champagne.

Hexagon-shaped peninsula with Champagne finish base.

214



215



SCHEDA TECNICA
GLAMOUR 2
Technical information
Glamorous 2

ANTA
 Door



DELTA

MANIGLIA
 Handle



PLANA

FINITURE UTILIZZATE
Finishes used

216

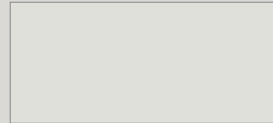

Laccato Perla Lucido
 Gloss Perla lacquer



Top Marmo Arabescato
 Arabescato marble worktop

VISTA IN PIANTA
 Plan

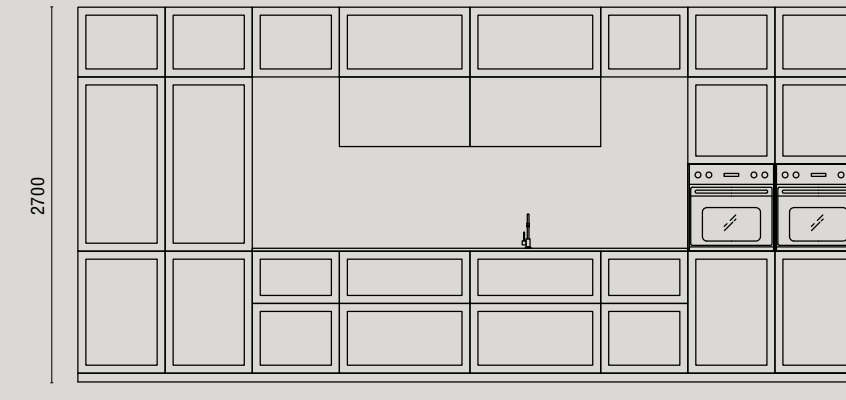
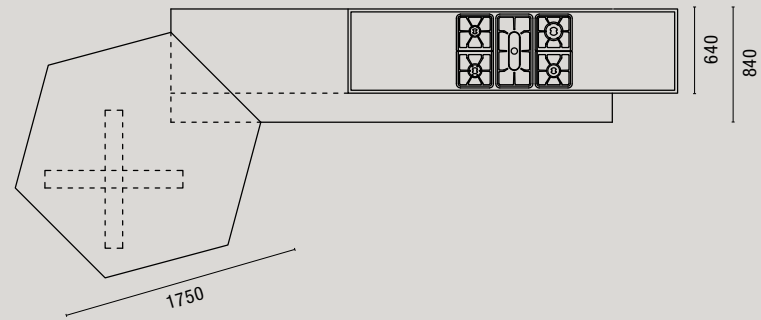

PROSPETTO A-A
 Front View A-A

5400

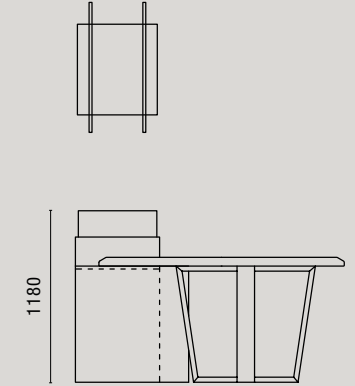

PROSPETTO C-C
 Front view C-C

1180

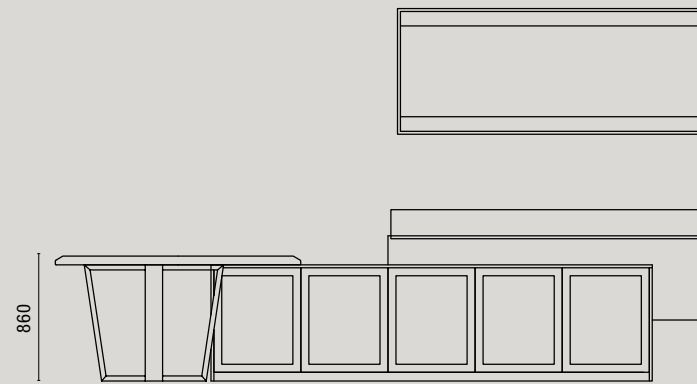

PROSPETTO D-D
 Front view D-D

860

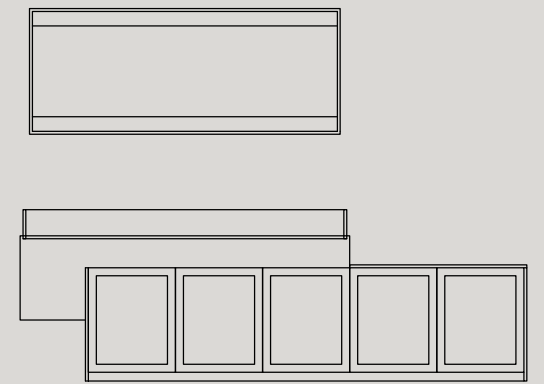

PROSPETTO B-B
 Front view B-B

1180

217

GLAMOUR 3
GLAMOUROUS 3

Anta: modello Phi e modello Alpha
 Finitura: Statuario Light Lucidato
 Natural Wood Termocotto
 Top Statuario Light Lucidato

Doors: Phi model and Alpha model
 Finish: Polished Statuario Light porcelain
 stoneware
 Heat-treated Natural Wood
 Polished Statuario Light porcelain stoneware
 worktop





Elemento boiserie a tutta parete, in finitura Natural Wood Termocotto, con mensole in vetro illuminate a led.

Heat-treated Natural Wood wall panelling extending over the entire wall, fitted with glass floating shelves and led lighting.



Bancone e cappa totalmente rivestiti in finitura Statuario Light Lucidato.

The work area and cooker hood are clad entirely with polished Statuario Light porcelain stoneware.







SCHEMA TECNICA
GLAMOUR 3
Technical information
Glamorous 3

ANTA
Door



PHI

ANTA
Door



ALPHA

FINITURE UTILIZZATE
Finishes used

228



Statuario Light Lucidato
 Polished Statuario Light porcelain
 stoneware



Natural Wood Termocotto
 Heat-treated Natural Wood



Top Statuario Light Lucidato
 Polished Statuario Light porcelain
 stoneware worktop

VISTA IN PIANTA
Plan

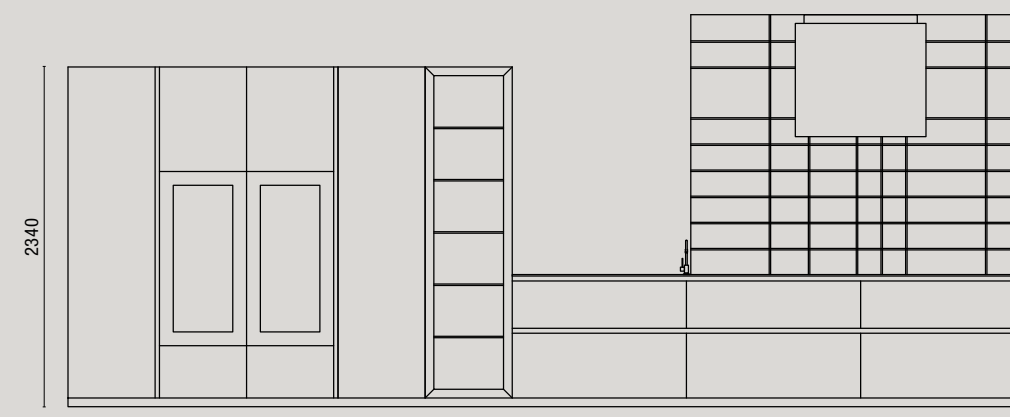
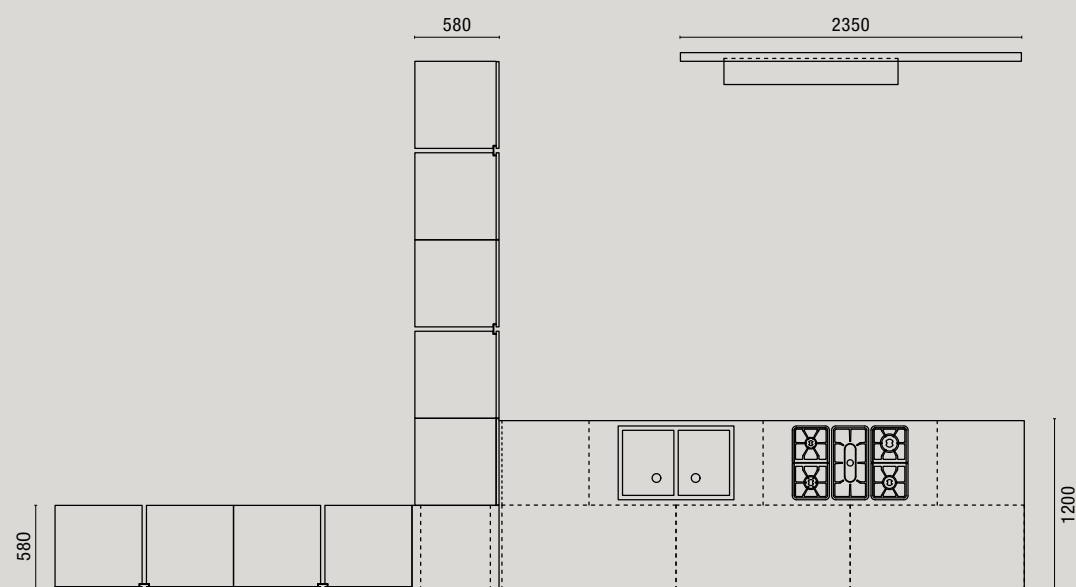

PROSPETTO A-A
 Front view A-A

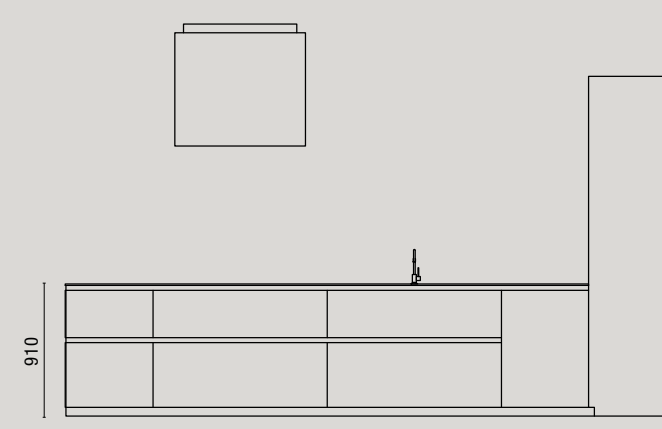

PROSPETTO B-B
 Front view B-B

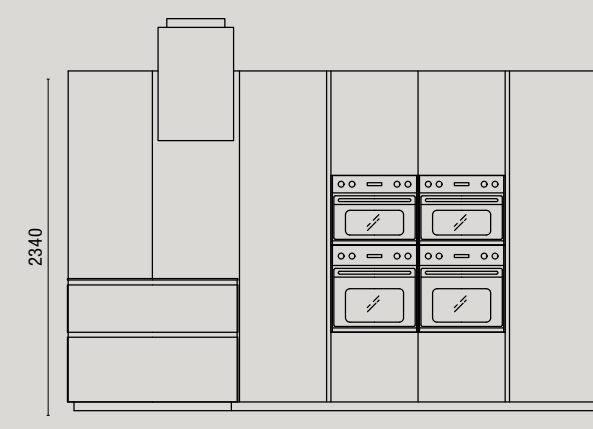

PROSPETTO C-C
 Front view C-C

229

TAVOLI

TABLES

SOUNION

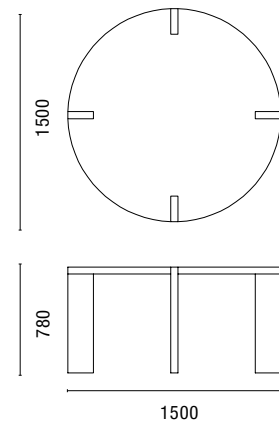

EPICURO

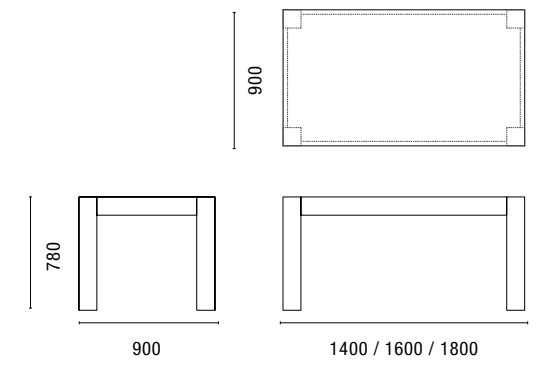

OLYMPIA

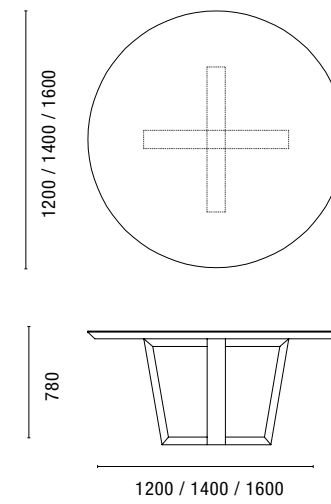

SEGESTA

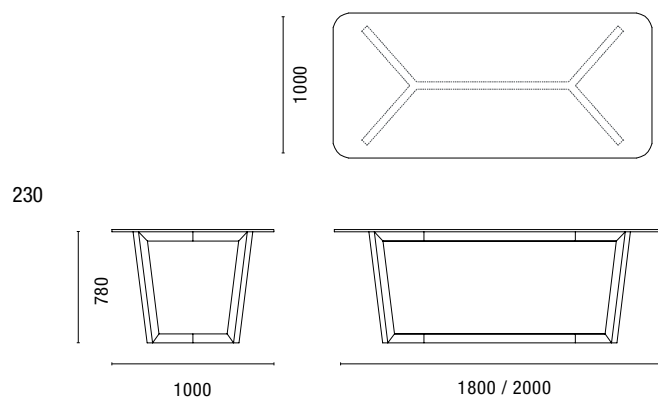

CIRENE

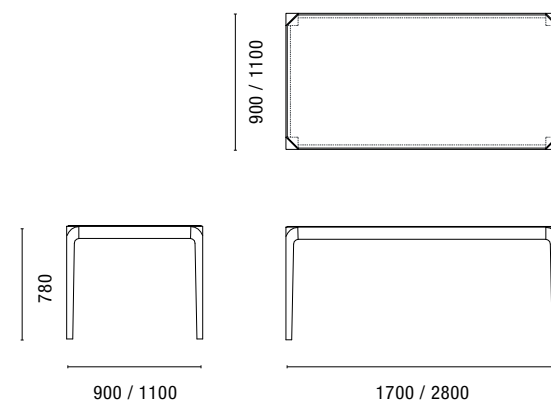

PAESTUM

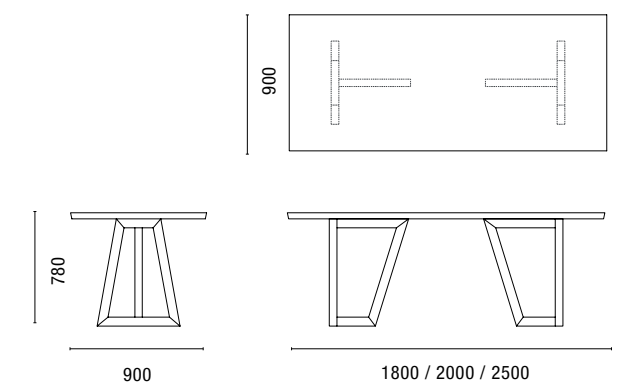

SEDIE CHAIRS

RIVESTIMENTI COVERINGS



2B9 ecopelle / eco-leather



4G9 ecopelle / eco-leather



3020-102 tessuto / fabric

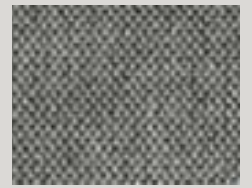

3020-119 tessuto / fabric

ADE

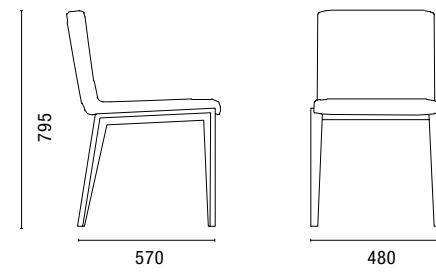

GEA

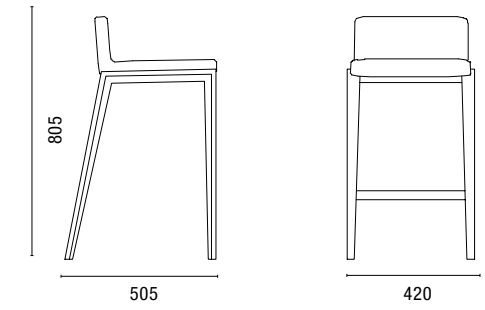

TETI



ARES

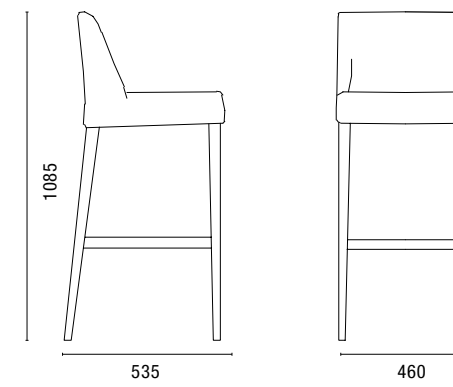

232

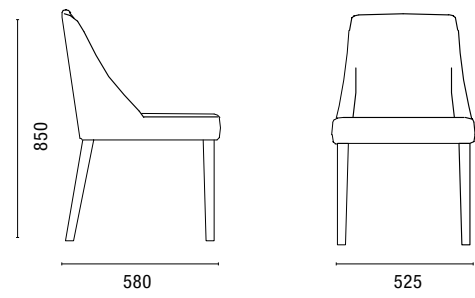

233

EKO

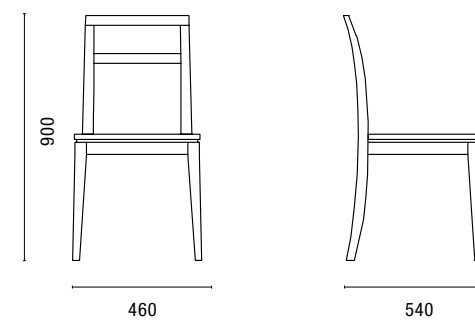

ARIA

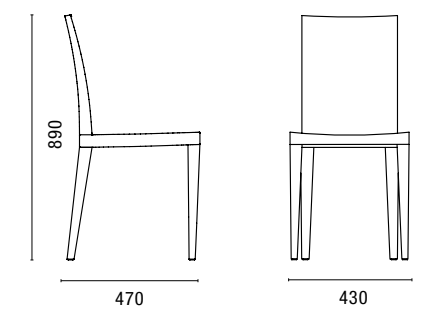

MATERIALI PER ANTE

MATERIALS AVAILABLE FOR DOORS

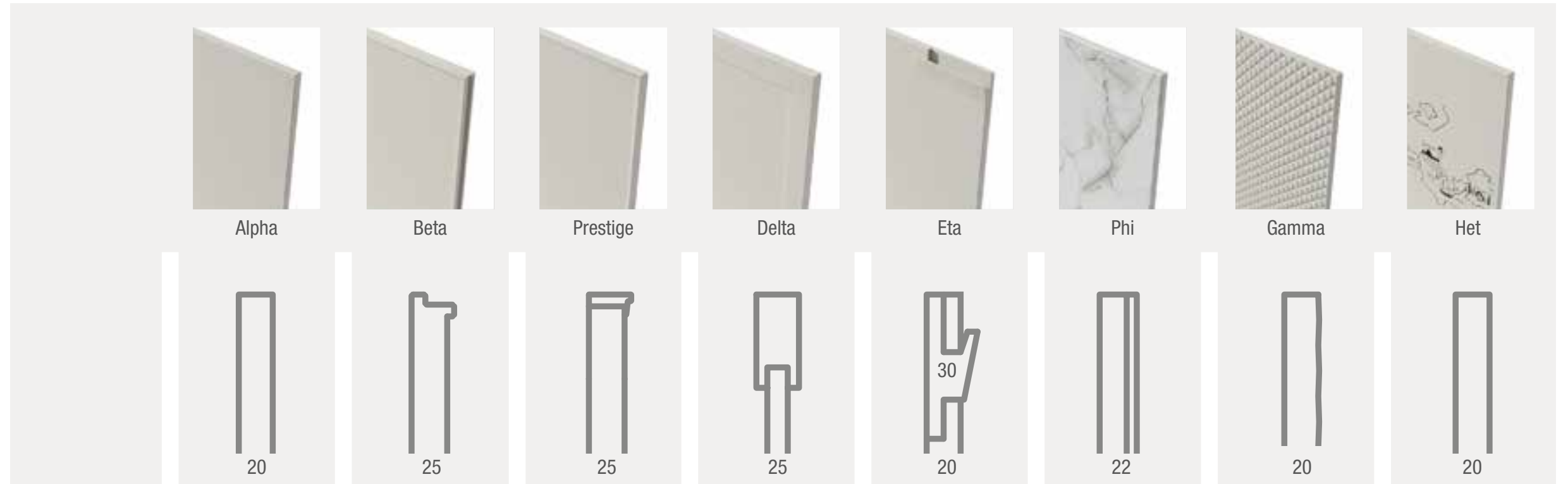

SOLID WOOD
 MASSELO 3 STRATI BUMP IN VENA
 3 LAYERS OF SOLID WOOD WITH A CONSISTENT SURFACE GRAIN (BUMP)

NOCE CANALETTO / BLACK WALNUT

ROVERE NODATO / KNOTTED OAK

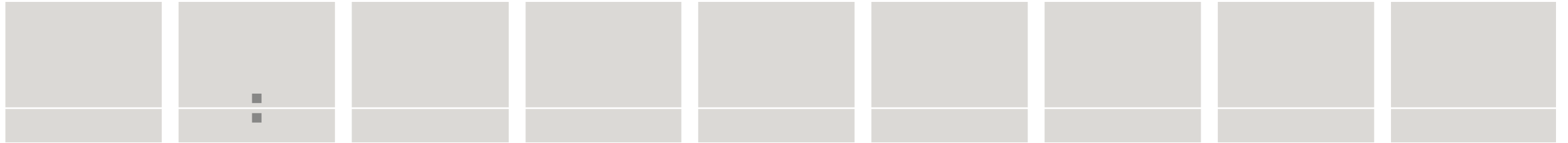

NATURAL WOOD
 MULTISTRATO MARINO
 MARINE PLYWOOD

NOCE CANALETTO / BLACK WALNUT

ROVERE TERMOTRATTATO / HEAT-TREATED OAK

ROVERE VINTAGE / VINTAGE OAK

ROVERE NODATO / KNOTTED OAK

OLMO / ELM

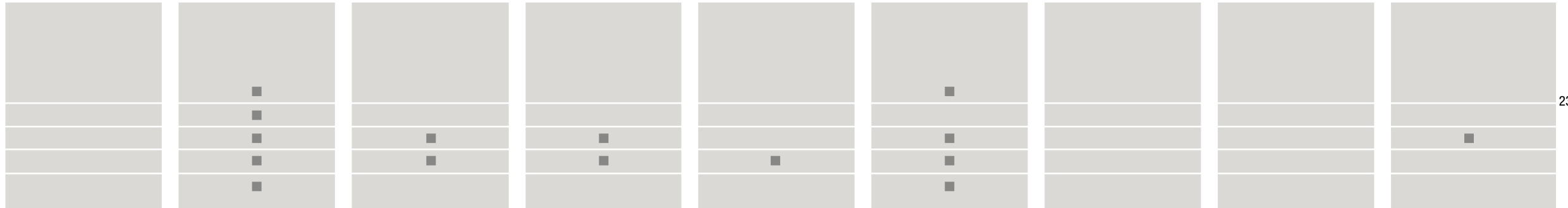

MDF

LACCATO OPACO / MATT LACQUERED

LACCATO LUCIDO 60 GLOSS / GLOSS 60 LACQUERED

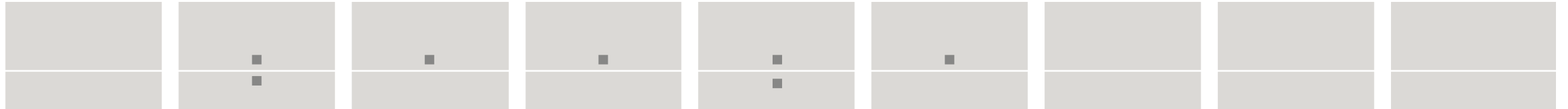

ANTA VETRO/GRES PORCELLANATO
 GLASS DOOR/PORCELAIN STONWARE
 TELAIO ALLUMINIO INTERO
 FULL ALUMINIUM FRAME

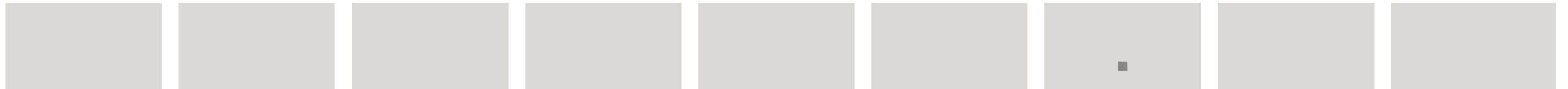

ROMBO / RHOMBUS

NOCE CANALETTO / BLACK WALNUT

LACCATO OPACO / MATT LACQUERED

LACCATO LUCIDO 60 GLOSS / GLOSS 60 LACQUERED



INCISIONE LASER / LASER ENGRAVING
 IN TUTTE LE FINITURE NATURAL WOOD
 IN ALL THE NATURAL WOOD FINISHES



MANIGLIE

HANDLES



LINEA



COLIBRI



LAMA



PLANA



EKO



GOLA PIATTA LEGNO H.3
FLAT WOODEN CHANNEL H.3



GOLA



PUSH

SOLID WOOD

SOLID WOOD

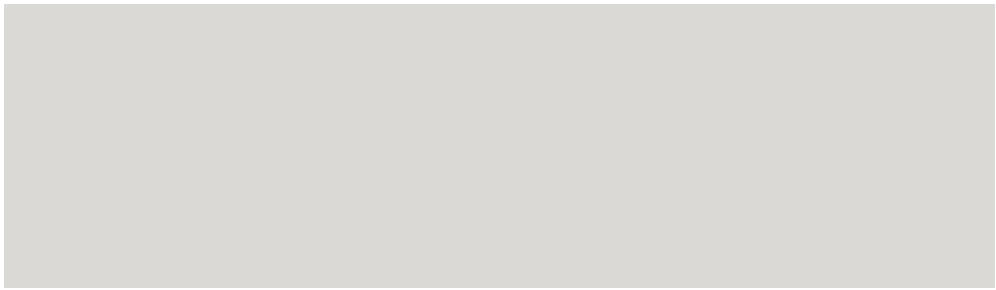

NOCE CANALETTO / BLACK WALNUT



ROVERE NODATO / KNOTTED OAK

NATURAL WOOD

NATURAL WOOD

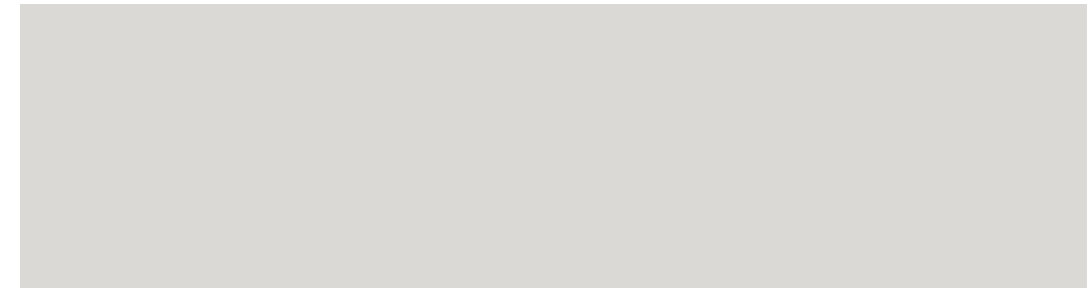

ROVERE VINTAGE / VINTAGE OAK



OLMO / ELM



NOCE CANALETTO / BLACK WALNUT



ROVERE TERMOTRATTATO / HEAT-TREATED OAK



ROVERE NODATO / KNOTTED OAK



MDF

MDF

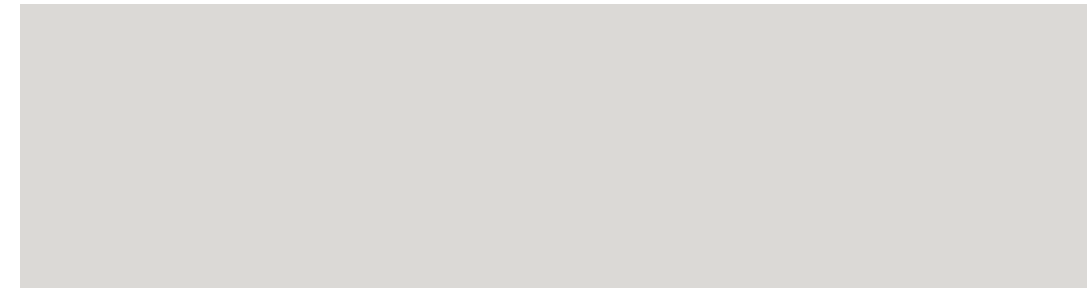

BIANCO • 0300-N

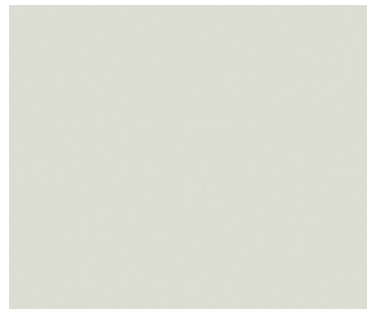

SETA • 1502-G50Y

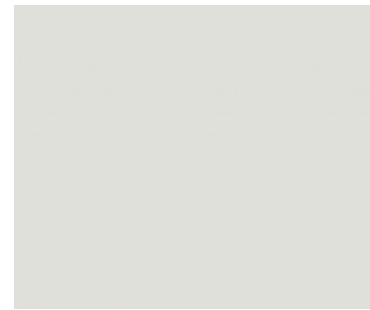

PERLA • 1500-N



POLVERE • 3005-G20Y



CASTORO • 5005-Y20R



CENERE • 5005-Y50R



CAPPUCCINO • 4010-G90Y



BOSCO • 7010-B30G

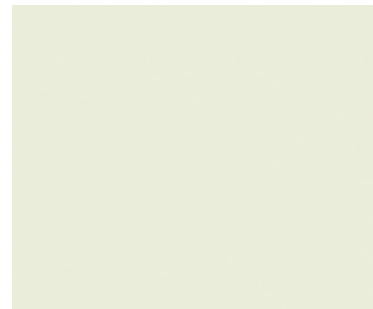

NEBBIA • 1005-G70Y



FUMO • 2005-G60Y



RUGIADA • 2502-Y



TORTORA • 4005-Y20R



PIOGGIA • 6000-N



NUVOLA • 4020-B10G



PETROLIO • 7010-B10G



PIETRA • 4005-B20G

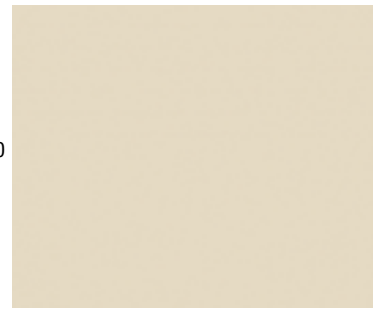

AVORIO • 1505-Y30R



CANAPA • 0907-Y10R

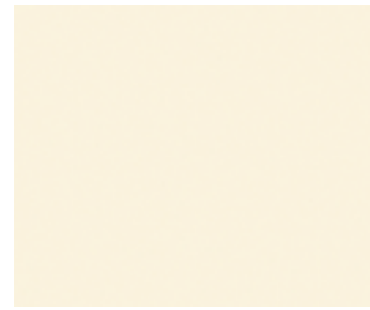

CORDA • 0804-Y30R



SABBIA • 2030-G90Y



RUBINO • 2570-R



TERRA • 6030-Y90R



CAFFÈ • 7010-Y70R



CORTECCIA • 8000-N



COLOMBA • 3500-N

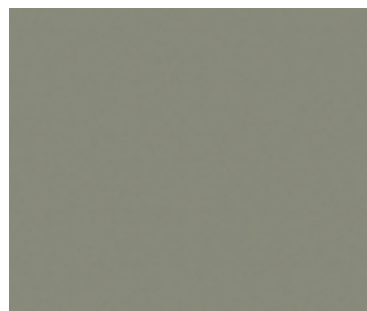

OMBRA • 5005-G80Y



SENAPE • 3005-Y50R

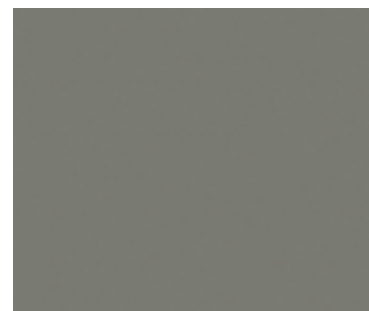

DAINO • 5502-Y



PIOMBO • 6502-G



CARBONE • 7502-Y



GRAFITE • 7502-B



NERO • 9000N

VETRI TRASPARENTI

GLASS TRANSPARENT

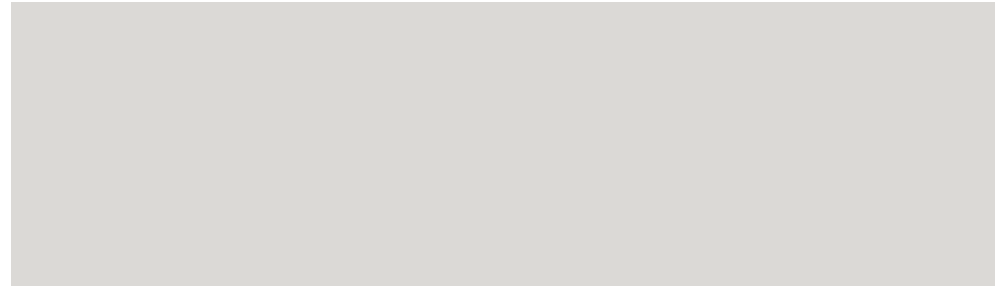

TRASPARENTE / TRANSPARENT



BRONZO / BRONZE



FUMÈ / SMOKED

VETRI LACCATI

LACQUERED GLASS

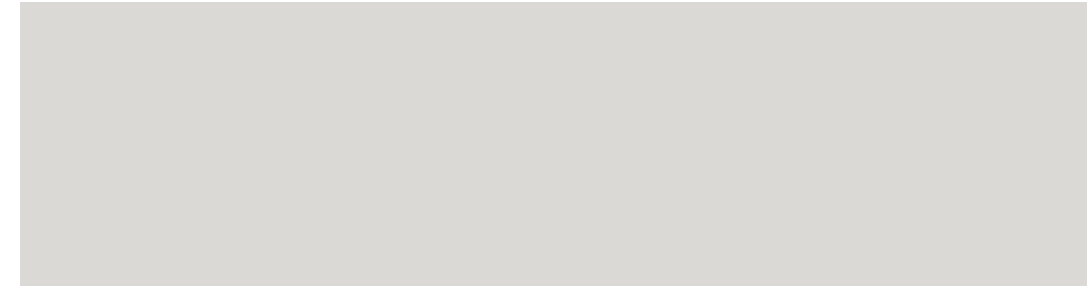

BIANCO • 0300-N

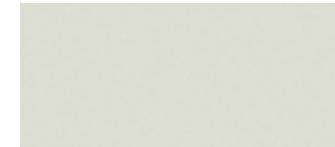

SETA • 1502-G50Y

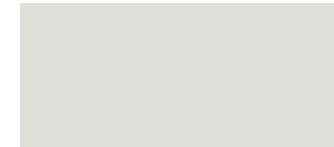

PERLA • 1500-N



POLVERE • 3005-G20Y



NEBBIA • 1005-G70Y



FUMO • 2005-G60Y



RUGIADA • 2502-Y



TORTORA • 4005-Y20R

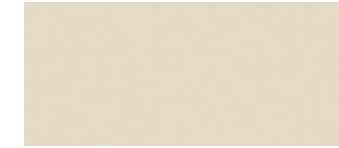

AVORIO • 1505-Y30R



CANAPA • 0907-Y10R



CORDA • 0804-Y30R



SABBIA • 2030-G90Y



COLOMBA • 3500-N



OMBRA • 5005-G80Y



SENAPE • 3005-Y50R



DAINO • 5502-Y



CREMA • 2020-Y20R



OCRA • 3040-Y10R



CARAMELLO • 4040-Y20R



ARANCIA • 3560-Y50R



CASTORO • 5005-Y20R



CENERE • 5005-Y50R



CAPPUCCINO • 4010-G90Y



BOSCO • 7010-B30G



PIOGGIA • 6000-N



NUVOLA • 4020-B10G



PETROLIO • 7010-B10G



PIETRA • 4005-B20G



RUBINO • 2570-R



TERRA • 6030-Y90R



CAFFÈ • 7010-Y70R



CORTECCIA • 8000-N



PIOMBO • 6502-G



CARBONE • 7502-Y



GRAFITE • 7502-B



NERO • 9000N

GRES PORCELLANATO

PORCELAIN STONEWARE



PIETRA LAVICA

Pietra Lavica



PEARL



BEIGE



GREY

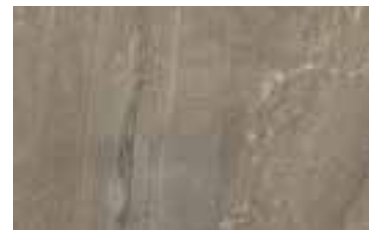

DARK



244 BLACK

MARMI

Marble



CALCATA



BIANCO LASA



BIANCO VENATO EXTRA



ARABESCATO



EXTRAWHITE



STATUARIO LIGHT



BLUE DE SAVOIE



BLACK VENATO

245

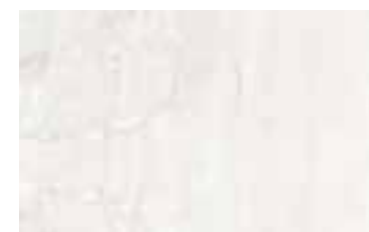

ONICE PERLA

METAL XXL

Metal XXL



WHITE



BLACK



GREY

MARMI NATURALI

NATURAL MARBLE

BIO MALTA

ECO MORTAR

OPACHI

Matt



CARRARA BIANCO CAT. A
WHITE CARRARA CAT. A



FIOR DI PESCO CARNICO GRIGIO CAT. B
FIOR DI PESCO CARNICO GRIGIO CAT. B

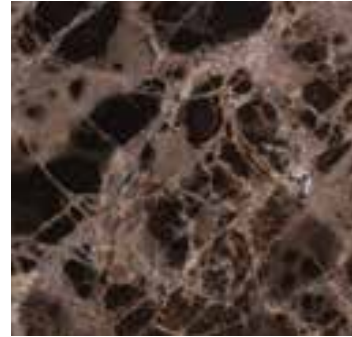

EMPERADOR DARK CAT. B
EMPERADOR DARK CAT. B

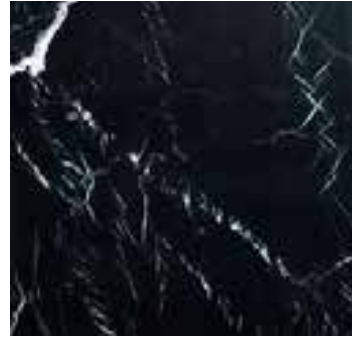

NERO DI MARQUINIA CAT. B
NERO DI MARQUINIA CAT. B

LUCIDI

Glossy



CARRARA BIANCO CAT. A
WHITE CARRARA CAT. A



FIOR DI PESCO CARNICO GRIGIO CAT. B
FIOR DI PESCO CARNICO GRIGIO CAT. B

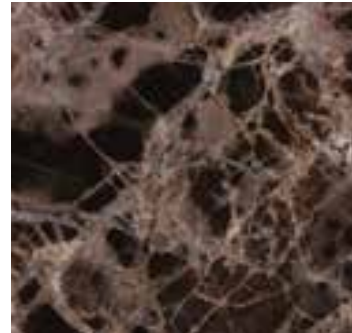

EMPERADOR DARK CAT. B
EMPERADOR DARK CAT. B



NERO DI MARQUINIA CAT. B
NERO DI MARQUINIA CAT. B



WENGÈ CAT. B
WENGÈ CAT. B



PIETRA
STONE



ARENARIA
SANDSTONE



COLORE 7045 QB
COLOUR 7045 QB



ARDESIA
SLATE



OLDLINE ARREDAMENTI SRL
Via Cal Larga, 56
31010 Mareno di Piave
Treviso - Italy
T. +39 0438 492506
F. +39 0438 492549
www.oldline.it
oldline@oldline.it

A.D. Marco Bortolin PHOTO 3D www.oecusdesign.it FOTO Corrado Covre FOTOLITO GIM Studio 1 (Verona) STAMPA ***** aprile 2017

